

# ATF 100G-4

100 METRISCHE TONNEN TRAGLAST / 100 METRIC TON CAPACITY

ALL  
TERRAIN  
CRANE



Maße (mm)  
 Dimensions (mm)  
 Dimensiones (mm)

445/95 R 25  
 (16.00 R 25)

DIN/ISO/EN

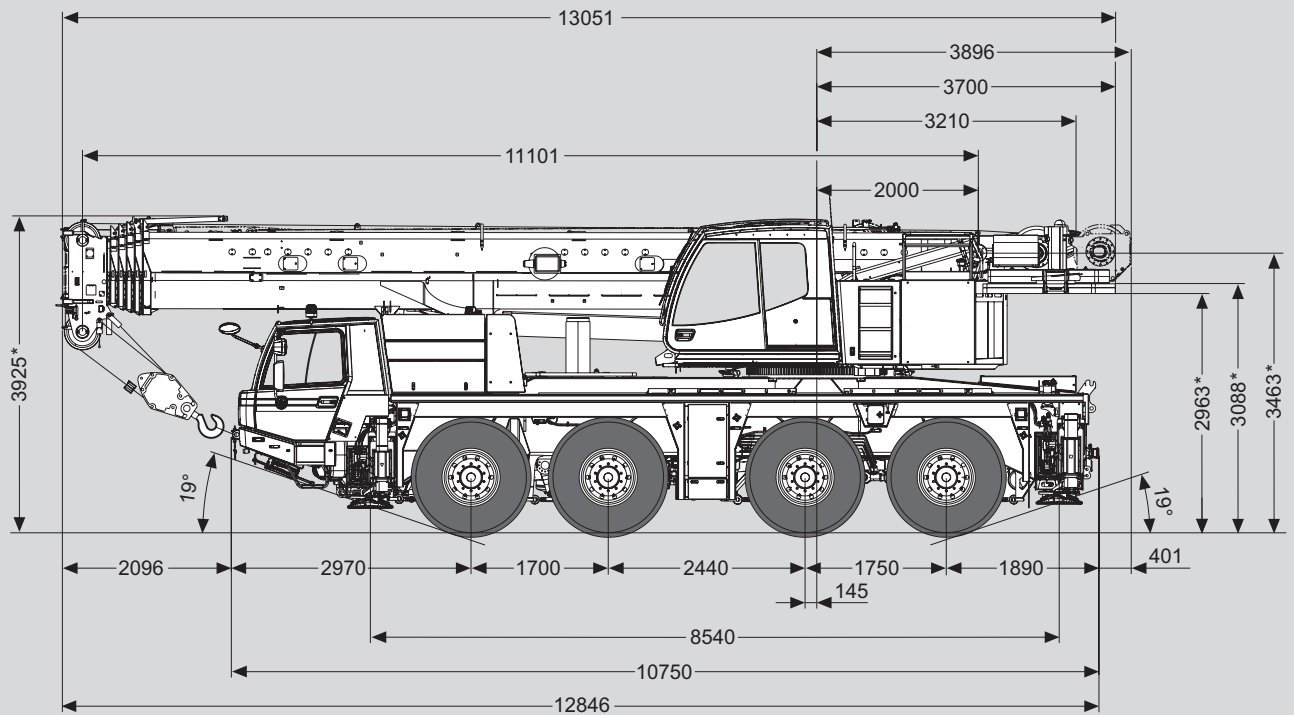

\* ± 100

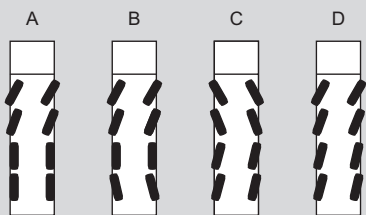
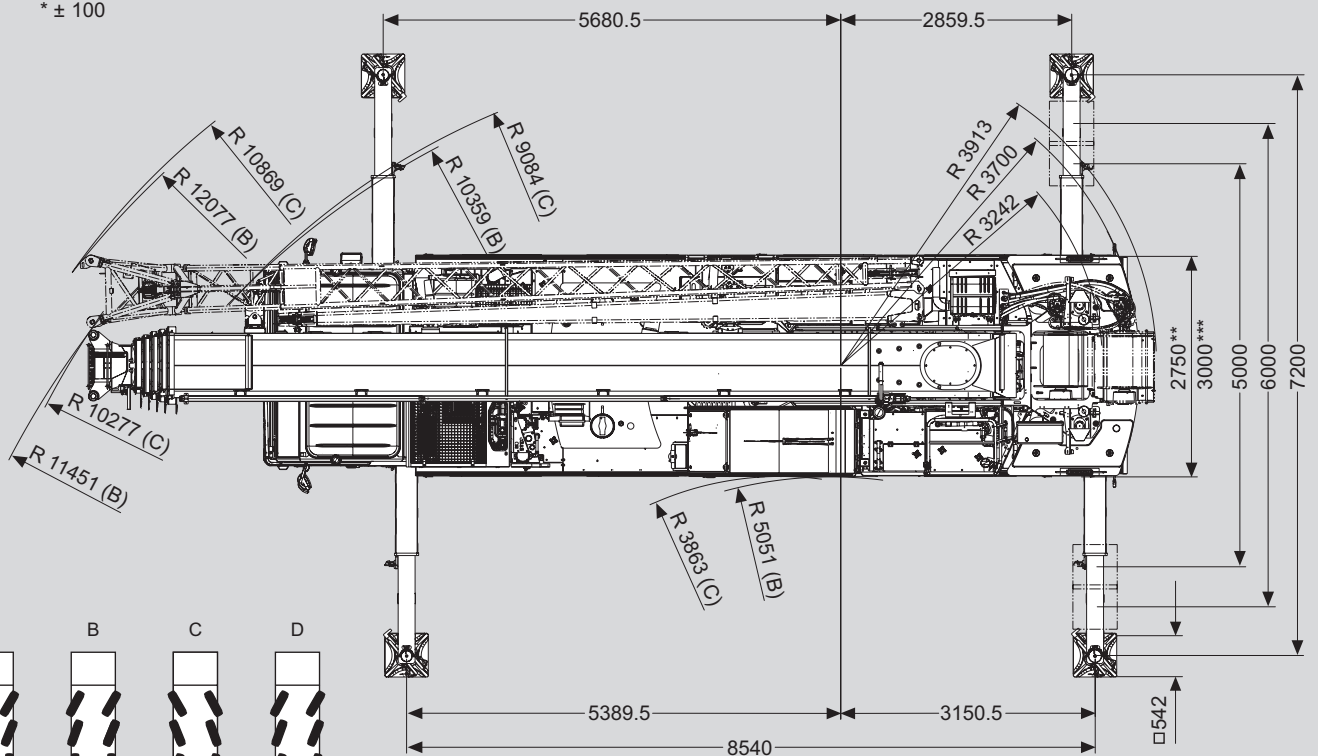

v > 25 km/h v < 25 km/h

\*\* 385/95 R 25 (14.00 R25), 445/95 R 25 (16.00 R25)  
 \*\*\* 525/80 R 25 (20.5 R25)

Gewichte / Geschwindigkeiten  
Weights / Working speeds  
Poids / Vitesses  
Pesos / Velocidades de trabajo

|  | Achse / Axle<br>Essieu / Eje | 1  | 2  | 3  | 4  | Gesamtgewicht / Total weight<br>Poids total / Peso total |
|--|------------------------------|----|----|----|----|--|
|  | (t)                          | 12 | 12 | 12 | 12 | 48*  |

\* Incl. 6,0 t Gegengewicht, 10 m / 18 m Auslegerverlängerung, Unterflasche, Hakengeschirr, Bereifung 445/95 R 25 (16.00 R 25).

\* Incl. 6.0 t counterweight, 10 m / 18 m boom extension, hook block, swivel hook, tyres 445/95 R 25 (16.00 R 25).

\* Incl. de 6,0 t contrepoids, 10 m / 18 m flèche, moufle, élingues, pneus 445/95 R 25 (16.00 R 25).

\* Incl. contrapeso de 6,0 t, 10 m / 18 m plumin, gancho, gancho de bola, neumáticos 445/95 R 25 (16.00 R 25).

|                             | Traglast / Lifting capacity / Force<br>de levage / Capacidad de elevación | Rollen / Sheaves<br>Pulies / Poleas | Stränge / Parts of line<br>Brins / Ramales de cable | Gewicht / Weight<br>Poid / Peso |
|-----------------------------|---|-------------------------------------|---|---------------------------------|
|                             | 59.1 t (Typ / Type / Typo 63)*  | 5                                   | 11  | 650 kg                          |
|                             | 38.1 t (Typ / Type / Typo 40)*  | 3                                   | 7   | 550 kg                          |
|                             | 38.1 t (Typ / Type / Typo 40)   | 3                                   | 7   | 550 kg                          |
|                             | 16.5 t (Typ / Type / Typo 20)   | 1                                   | 3   | 300 kg                          |
| 5.6 t (Typ / Type / Typo 6) | –   | 1                                   | 150 kg  |                                 |

\* Doppelhaken

\* Rams horn

\* Moufle avec crochet marin

\* Gancho doble



|                             | 1 | 2 | 3  | 4  | 5  | 6  | 7  | 8  | 9  | 10 | 11 | 12 | R1 | R2 |     |
|-----------------------------|---|---|----|----|----|----|----|----|----|----|----|----|----|----|-----|
|                             |   |   |    |    |    |    |    |    |    |    |    |    |    |    |     |
| km/h                        | 3 | 4 | 5  | 6  | 8  | 10 | 13 | 17 | 22 | 28 | 36 | 46 | 3  | 4  | 74% |
|                             | 5 | 7 | 9  | 12 | 15 | 19 | 25 | 32 | 41 | 52 | 67 | 85 | 6  | 8  |     |
| 445/95 R 25<br>(16.00 R 25) | 3 | 4 | 5  | 7  | 9  | 11 | 15 | 19 | 24 | 31 | 39 | 50 | 3  | 4  | 65% |
| km/h                        | 6 | 8 | 10 | 13 | 16 | 20 | 27 | 34 | 44 | 57 | 72 | 85 | 6  | 8  |     |

| V+ | Stufenlos<br>Infinitely variable<br>Progressivement variable<br>Infinitamente variable | Seil<br>Rope<br>Câble<br>Cable | Max. Seilzug<br>Max. single line pull<br>Effort maxi au brin simple<br>Trio máximo por ramal |
|----|--|--------------------------------|--|
|    | 0 - 115 m/min<br>für einfachen Strang<br>single line<br>au brin simple<br>ramal simple | 18 mm / 230 m                  | 55 kN  |
|    | 0 - 115 m/min<br>für einfachen Strang<br>single line<br>au brin simple<br>ramal simple | 18 mm / 230 m                  | 55 kN  |
|    | 0 - 2 min <sup>-1</sup>  |                                | 0° + 180°  |
|    | - 1° – + 82.4°<br>ca. 30 s<br>approx. 30 s<br>env. 30 s<br>aproximadamente 30 s        |                                |  |
|    | 11.1 m – 51.2 m<br>ca. 310 s<br>approx. 310 s<br>env. 310 s<br>aproximadamente 310 s   |                                |  |

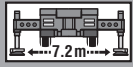
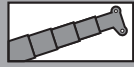

Hubhöhen  
Lifting heights  
Hauteurs de levage  
Alturas de elevación



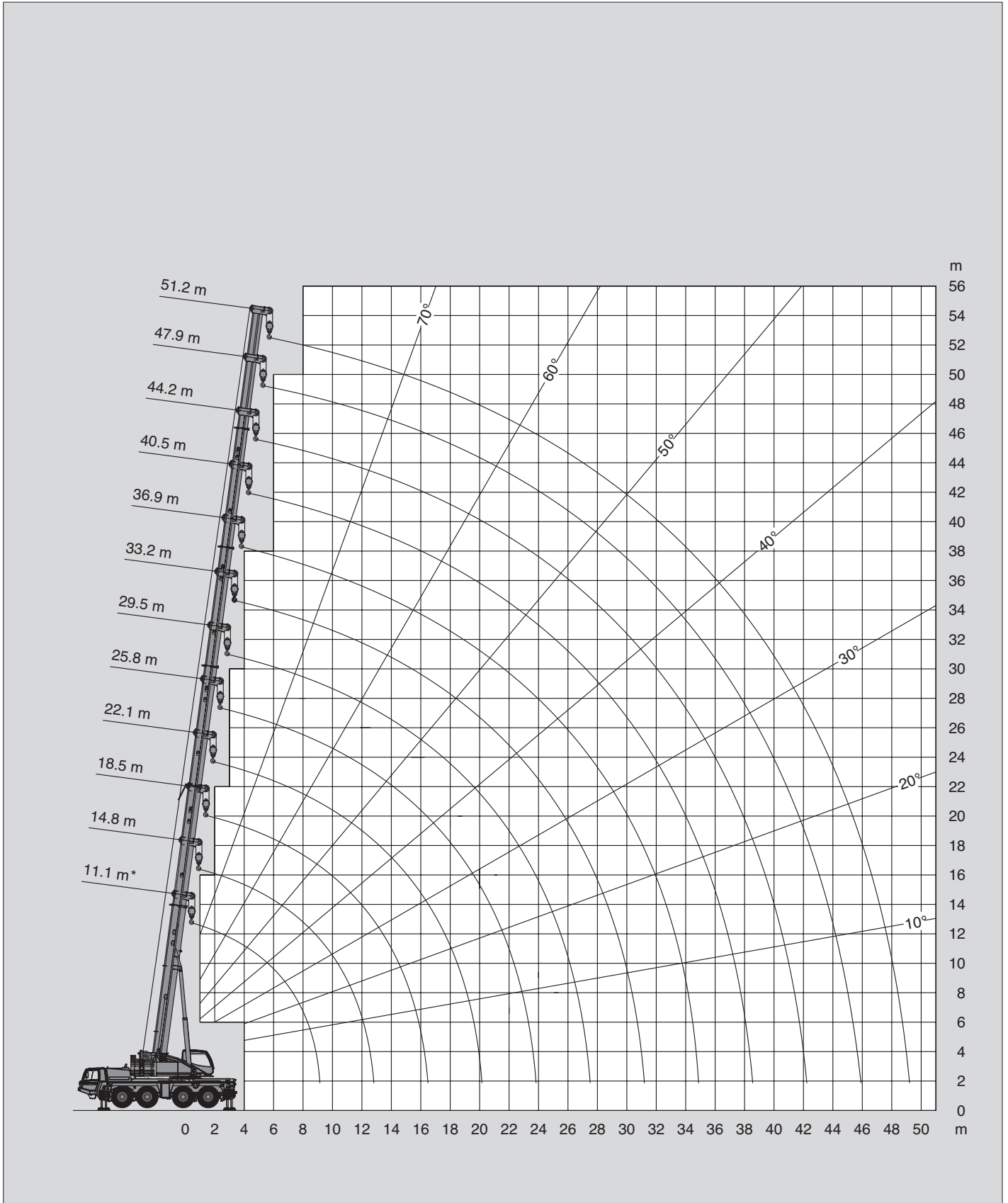

22.5t

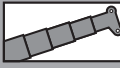
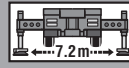
DIN/ISO/EN

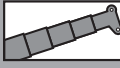
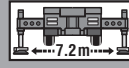

|    <b>22.5t</b> <span style="float: right; border: 1px solid black; padding: 2px;">DIN/ISO/EN</span> |         |        |        |        |        |        |        |        |        |        |        |        |        |
|--|---------|--------|--------|--------|--------|--------|--------|--------|--------|--------|--------|--------|--------|
| <br>m  | 11.1 m* | 11.1 m | 14.8 m | 18.5 m | 22.1 m | 25.8 m | 29.5 m | 33.2 m | 36.9 m | 40.5 m | 44.2 m | 47.9 m | 51.2 m |
| 2.3  | 100.0   |        |        |        |        |        |        |        |        |        |        |        |        |
| 2.5  | 90.0    |        |        |        |        |        |        |        |        |        |        |        |        |
| 3.0  | 81.6    | 76.1   | 65.0   | 65.0   |        |        |        |        |        |        |        |        |        |
| 3.5  | 74.6    | 69.9   | 65.0   | 65.0   | 50.0   |        |        |        |        |        |        |        |        |
| 4.0  | 68.3    | 64.1   | 63.5   | 61.4   | 50.0   | 41.3   |        |        |        |        |        |        |        |
| 4.5  | 62.7    | 59.0   | 58.5   | 56.7   | 50.0   | 41.3   |        |        |        |        |        |        |        |
| 5.0  | 57.8    | 54.6   | 54.0   | 52.7   | 50.0   | 39.2   | 31.6   |        |        |        |        |        |        |
| 6.0  | 50.0    | 47.2   | 46.6   | 46.8   | 45.9   | 34.9   | 31.6   | 23.8   |        |        |        |        |        |
| 7.0  | 42.5    | 41.2   | 40.7   | 40.8   | 40.8   | 33.0   | 28.9   | 23.8   | 19.7   |        |        |        |        |
| 8.0  | 36.6    | 35.5   | 35.4   | 35.5   | 35.8   | 31.1   | 28.5   | 23.8   | 19.7   | 15.8   |        |        |        |
| 9.0  | 24.9    | 24.0   | 31.2   | 31.4   | 30.8   | 29.4   | 28.5   | 22.6   | 19.7   | 15.8   | 12.9   |        |        |
| 10.0   |         |        | 26.4   | 26.6   | 26.7   | 27.5   | 26.0   | 20.9   | 19.6   | 15.8   | 12.9   | 10.2   |        |
| 11.0   |         |        | 22.4   | 23.4   | 24.7   | 24.3   | 23.1   | 19.4   | 18.2   | 15.8   | 12.9   | 10.2   | 8.9    |
| 12.0   |         |        | 20.0   | 21.7   | 21.7   | 21.5   | 20.7   | 18.0   | 17.0   | 15.8   | 12.9   | 10.2   | 8.9    |
| 14.0   |         |        |        | 17.1   | 17.1   | 16.9   | 16.5   | 16.2   | 14.9   | 14.1   | 12.9   | 10.2   | 8.9    |
| 16.0   |         |        |        | 13.9   | 13.9   | 13.7   | 13.3   | 13.8   | 12.9   | 12.6   | 11.8   | 10.2   | 8.9    |
| 18.0   |         |        |        |        | 11.6   | 11.4   | 11.0   | 11.4   | 11.6   | 10.7   | 10.8   | 10.0   | 8.9    |
| 20.0   |         |        |        |        | 9.6    | 9.6    | 9.2    | 9.6    | 9.8    | 9.5    | 9.5    | 9.1    | 8.6    |
| 22.0   |         |        |        |        |        | 8.2    | 8.4    | 8.2    | 8.4    | 8.5    | 8.4    | 8.0    | 7.9    |
| 24.0   |         |        |        |        |        |        | 7.8    | 7.1    | 7.6    | 7.4    | 7.2    | 6.9    | 6.9    |
| 26.0   |         |        |        |        |        |        | 6.9    | 6.5    | 6.7    | 6.4    | 6.3    | 6.0    | 5.9    |
| 28.0   |         |        |        |        |        |        |        | 5.9    | 5.9    | 5.6    | 5.5    | 5.2    | 5.2    |
| 30.0   |         |        |        |        |        |        |        | 5.3    | 5.2    | 4.9    | 4.8    | 4.5    | 4.5    |
| 32.0   |         |        |        |        |        |        |        |        | 4.6    | 4.4    | 4.2    | 3.9    | 3.9    |
| 34.0   |         |        |        |        |        |        |        |        | 4.1    | 3.9    | 3.7    | 3.4    | 3.4    |
| 36.0   |         |        |        |        |        |        |        |        |        | 3.4    | 3.3    | 3.0    | 3.0    |
| 38.0   |         |        |        |        |        |        |        |        |        | 3.1    | 2.9    | 2.6    | 2.6    |
| 40.0   |         |        |        |        |        |        |        |        |        |        | 2.5    | 2.2    | 2.2    |
| 42.0   |         |        |        |        |        |        |        |        |        |        | 2.2    | 1.9    | 1.9    |
| 44.0   |         |        |        |        |        |        |        |        |        |        |        | 1.6    | 1.6    |
| 46.0   |         |        |        |        |        |        |        |        |        |        |        |        | 1.4    |
| 48.0   |         |        |        |        |        |        |        |        |        |        |        |        | 1.2    |

\* Nach hinten / \* Over rear / \* A l'arrière / \* Sobre la parte trasera

|    <b>16.3t</b> <span style="float: right; border: 1px solid black; padding: 2px;">DIN/ISO/EN</span> |         |        |        |        |        |        |        |        |        |        |        |        |        |
|--|---------|--------|--------|--------|--------|--------|--------|--------|--------|--------|--------|--------|--------|
| <br>m  | 11.1 m* | 11.1 m | 14.8 m | 18.5 m | 22.1 m | 25.8 m | 29.5 m | 33.2 m | 36.9 m | 40.5 m | 44.2 m | 47.9 m | 51.2 m |
| 2.3  | 100.0   |        |        |        |        |        |        |        |        |        |        |        |        |
| 2.5  | 90.0    |        |        |        |        |        |        |        |        |        |        |        |        |
| 3.0  | 81.6    | 76.3   | 65.0   | 65.0   |        |        |        |        |        |        |        |        |        |
| 3.5  | 74.0    | 69.4   | 65.0   | 65.0   | 50.0   |        |        |        |        |        |        |        |        |
| 4.0  | 67.5    | 63.5   | 63.0   | 61.4   | 50.0   | 41.3   |        |        |        |        |        |        |        |
| 4.5  | 61.9    | 58.3   | 57.8   | 56.7   | 50.0   | 41.3   |        |        |        |        |        |        |        |
| 5.0  | 57.1    | 53.8   | 53.3   | 52.7   | 50.0   | 39.2   | 31.6   |        |        |        |        |        |        |
| 6.0  | 47.9    | 46.4   | 45.9   | 46.0   | 45.6   | 34.9   | 31.6   | 23.8   |        |        |        |        |        |
| 7.0  | 40.4    | 39.7   | 39.2   | 38.5   | 36.8   | 33.0   | 28.9   | 23.8   | 19.7   |        |        |        |        |
| 8.0  | 34.2    | 34.2   | 33.2   | 31.8   | 30.6   | 31.1   | 28.5   | 23.8   | 19.7   | 15.8   |        |        |        |
| 9.0  | 24.9    | 24.0   | 26.8   | 26.9   | 28.1   | 26.8   | 25.2   | 22.6   | 19.7   | 15.8   | 12.9   |        |        |
| 10.0   |         |        | 22.2   | 24.7   | 24.6   | 23.4   | 22.0   | 20.7   | 19.6   | 15.8   | 12.9   | 10.2   |        |
| 11.0   |         |        | 20.6   | 21.2   | 21.2   | 20.7   | 19.5   | 18.7   | 17.7   | 15.8   | 12.9   | 10.2   | 8.9    |
| 12.0   |         |        | 17.9   | 18.4   | 18.5   | 18.2   | 17.4   | 17.4   | 15.8   | 15.5   | 12.9   | 10.2   | 8.9    |
| 14.0   |         |        |        | 14.4   | 14.4   | 14.2   | 13.8   | 14.2   | 14.0   | 12.6   | 12.5   | 10.2   | 8.9    |
| 16.0   |         |        |        | 11.6   | 11.9   | 11.4   | 11.2   | 11.5   | 11.7   | 11.1   | 11.0   | 10.2   | 8.9    |
| 18.0   |         |        |        |        | 10.1   | 9.7    | 10.1   | 9.5    | 9.9    | 9.8    | 9.5    | 9.0    | 8.8    |
| 20.0   |         |        |        |        | 8.6    | 8.5    | 8.6    | 8.4    | 8.4    | 8.2    | 8.0    | 7.7    | 7.5    |
| 22.0   |         |        |        |        |        | 7.3    | 7.4    | 7.3    | 7.2    | 7.0    | 6.8    | 6.5    | 6.5    |
| 24.0   |         |        |        |        |        |        | 6.4    | 6.3    | 6.2    | 6.0    | 5.8    | 5.5    | 5.5    |
| 26.0   |         |        |        |        |        |        | 5.6    | 5.4    | 5.4    | 5.1    | 5.0    | 4.7    | 4.6    |
| 28.0   |         |        |        |        |        |        |        | 4.7    | 4.7    | 4.4    | 4.3    | 3.9    | 3.9    |
| 30.0   |         |        |        |        |        |        |        | 4.2    | 4.1    | 3.8    | 3.7    | 3.4    | 3.3    |
| 32.0   |         |        |        |        |        |        |        |        | 3.6    | 3.3    | 3.1    | 2.8    | 2.8    |
| 34.0   |         |        |        |        |        |        |        |        | 3.1    | 2.9    | 2.7    | 2.4    | 2.4    |
| 36.0   |         |        |        |        |        |        |        |        |        | 2.5    | 2.3    | 2.0    | 2.0    |
| 38.0   |         |        |        |        |        |        |        |        |        | 2.2    | 2.0    | 1.7    | 1.7    |
| 40.0   |         |        |        |        |        |        |        |        |        |        | 1.7    | 1.4    | 1.3    |
| 42.0   |         |        |        |        |        |        |        |        |        |        | 1.4    | 1.1    | 1.1    |

\* Nach hinten / \* Over rear / \* A l'arrière / \* Sobre la parte trasera



Tragfähigkeiten  
Lifting capacities  
Capacités de levage  
Capacidades de elevación







| → m  | 11.1 m* | 11.1 m | 14.8 m | 18.5 m | 22.1 m | 25.8 m | 29.5 m | 33.2 m | 36.9 m | 40.5 m | 44.2 m | 47.9 m | 51.2 m |
|------|---------|--------|--------|--------|--------|--------|--------|--------|--------|--------|--------|--------|--------|
| 2.3  | 100.0   |        |        |        |        |        |        |        |        |        |        |        |        |
| 2.5  | 90.0    |        |        |        |        |        |        |        |        |        |        |        |        |
| 3.0  | 81.0    | 75.7   | 65.0   | 65.0   |        |        |        |        |        |        |        |        |        |
| 3.5  | 73.2    | 68.8   | 65.0   | 65.0   | 50.0   |        |        |        |        |        |        |        |        |
| 4.0  | 66.7    | 62.7   | 62.3   | 61.4   | 50.0   | 41.3   |        |        |        |        |        |        |        |
| 4.5  | 61.2    | 57.6   | 57.1   | 56.7   | 50.0   | 41.3   |        |        |        |        |        |        |        |
| 5.0  | 55.5    | 53.1   | 52.6   | 51.9   | 49.5   | 39.2   | 31.6   |        |        |        |        |        |        |
| 6.0  | 45.5    | 44.7   | 43.1   | 40.2   | 38.0   | 34.9   | 31.6   | 23.8   |        |        |        |        |        |
| 7.0  | 36.7    | 36.7   | 33.9   | 31.9   | 31.8   | 30.9   | 28.5   | 23.8   | 19.7   |        |        |        |        |
| 8.0  | 28.4    | 28.4   | 27.4   | 27.9   | 27.6   | 26.0   | 24.3   | 22.7   | 19.7   | 15.8   |        |        |        |
| 9.0  | 22.9    | 22.9   | 23.4   | 24.6   | 23.5   | 22.3   | 20.9   | 20.6   | 18.7   | 15.8   | 12.9   |        |        |
| 10.0 |         |        | 20.0   | 20.6   | 20.4   | 19.4   | 18.2   | 18.0   | 16.3   | 15.8   | 12.9   | 10.2   |        |
| 11.0 |         |        | 17.0   | 17.5   | 17.6   | 17.1   | 16.0   | 15.9   | 15.7   | 14.1   | 12.9   | 10.2   | 8.9    |
| 12.0 |         |        | 14.7   | 15.2   | 15.2   | 15.0   | 14.2   | 14.2   | 14.0   | 12.9   | 12.3   | 10.2   | 8.9    |
| 14.0 |         |        |        | 11.7   | 12.3   | 12.0   | 12.4   | 11.6   | 11.8   | 11.1   | 10.6   | 10.0   | 8.9    |
| 16.0 |         |        |        | 9.4    | 9.9    | 9.9    | 10.0   | 9.9    | 9.8    | 9.2    | 8.8    | 8.2    | 8.0    |
| 18.0 |         |        |        |        | 8.1    | 8.1    | 8.2    | 8.0    | 8.0    | 7.7    | 7.3    | 6.8    | 6.6    |
| 20.0 |         |        |        |        | 6.7    | 6.7    | 6.8    | 6.7    | 6.6    | 6.3    | 6.2    | 5.7    | 5.6    |
| 22.0 |         |        |        |        |        | 5.6    | 5.7    | 5.6    | 5.5    | 5.3    | 5.1    | 4.8    | 4.7    |
| 24.0 |         |        |        |        |        |        | 4.9    | 4.7    | 4.7    | 4.4    | 4.3    | 3.9    | 3.9    |
| 26.0 |         |        |        |        |        |        | 4.2    | 4.0    | 3.9    | 3.7    | 3.5    | 3.2    | 3.2    |
| 28.0 |         |        |        |        |        |        |        | 3.4    | 3.4    | 3.1    | 3.0    | 2.6    | 2.6    |
| 30.0 |         |        |        |        |        |        |        | 2.9    | 2.9    | 2.6    | 2.5    | 2.1    | 2.1    |
| 32.0 |         |        |        |        |        |        |        |        | 2.4    | 2.2    | 2.0    | 1.7    | 1.7    |
| 34.0 |         |        |        |        |        |        |        |        | 2.1    | 1.8    | 1.6    | 1.3    | 1.3    |
| 36.0 |         |        |        |        |        |        |        |        |        | 1.5    | 1.3    | 1.0    | 1.0    |
| 38.0 |         |        |        |        |        |        |        |        |        | 1.2    | 1.0    |        |        |

\* Nach hinten / \* Over rear / \* A l'arrière / \* Sobre la parte trasera



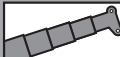



| → m  | 11.1 m* | 11.1 m | 14.8 m | 18.5 m | 22.1 m | 25.8 m | 29.5 m | 33.2 m | 36.9 m | 40.5 m | 44.2 m | 47.9 m | 51.2 m |
|------|---------|--------|--------|--------|--------|--------|--------|--------|--------|--------|--------|--------|--------|
| 2.3  | 100.0   |        |        |        |        |        |        |        |        |        |        |        |        |
| 2.5  | 90.0    |        |        |        |        |        |        |        |        |        |        |        |        |
| 3.0  | 80.3    | 75.3   | 65.0   | 65.0   |        |        |        |        |        |        |        |        |        |
| 3.5  | 72.6    | 68.2   | 65.0   | 65.0   | 50.0   |        |        |        |        |        |        |        |        |
| 4.0  | 66.1    | 62.2   | 61.7   | 61.4   | 50.0   | 41.3   |        |        |        |        |        |        |        |
| 4.5  | 59.9    | 57.0   | 56.5   | 53.3   | 50.0   | 41.3   |        |        |        |        |        |        |        |
| 5.0  | 53.5    | 52.0   | 50.4   | 46.1   | 42.9   | 39.0   | 31.6   |        |        |        |        |        |        |
| 6.0  | 42.2    | 42.2   | 37.2   | 34.6   | 34.1   | 33.0   | 29.1   | 23.8   |        |        |        |        |        |
| 7.0  | 31.7    | 31.7   | 29.1   | 29.9   | 28.7   | 26.8   | 24.9   | 23.1   | 19.7   |        |        |        |        |
| 8.0  | 24.4    | 24.4   | 25.1   | 25.1   | 23.9   | 22.5   | 20.9   | 20.6   | 18.6   | 15.8   |        |        |        |
| 9.0  | 19.5    | 19.6   | 20.7   | 21.2   | 20.3   | 19.2   | 17.9   | 17.7   | 16.1   | 15.3   | 12.9   |        |        |
| 10.0 |         |        | 17.2   | 17.7   | 17.6   | 16.5   | 16.3   | 15.3   | 15.0   | 13.2   | 12.9   | 10.2   |        |
| 11.0 |         |        | 14.5   | 15.0   | 15.5   | 14.6   | 14.9   | 14.0   | 13.6   | 12.8   | 11.4   | 10.2   | 8.9    |
| 12.0 |         |        | 12.3   | 12.9   | 13.5   | 13.5   | 13.2   | 12.6   | 12.1   | 11.4   | 10.8   | 10.0   | 8.9    |
| 14.0 |         |        |        | 9.8    | 10.3   | 10.3   | 10.4   | 10.1   | 9.7    | 9.1    | 8.6    | 8.0    | 7.8    |
| 16.0 |         |        |        | 7.6    | 8.1    | 8.1    | 8.2    | 8.1    | 8.0    | 7.4    | 7.0    | 6.5    | 6.3    |
| 18.0 |         |        |        |        | 6.5    | 6.6    | 6.6    | 6.5    | 6.5    | 6.2    | 5.8    | 5.3    | 5.1    |
| 20.0 |         |        |        |        | 5.4    | 5.4    | 5.5    | 5.3    | 5.3    | 5.0    | 4.8    | 4.3    | 4.2    |
| 22.0 |         |        |        |        |        | 4.5    | 4.5    | 4.4    | 4.3    | 4.1    | 3.9    | 3.5    | 3.4    |
| 24.0 |         |        |        |        |        |        | 3.8    | 3.6    | 3.6    | 3.3    | 3.2    | 2.9    | 2.8    |
| 26.0 |         |        |        |        |        |        | 3.2    | 3.0    | 3.0    | 2.7    | 2.6    | 2.2    | 2.2    |
| 28.0 |         |        |        |        |        |        |        | 2.5    | 2.5    | 2.2    | 2.0    | 1.7    | 1.7    |
| 30.0 |         |        |        |        |        |        |        | 2.1    | 2.0    | 1.8    | 1.6    | 1.3    | 1.3    |
| 32.0 |         |        |        |        |        |        |        |        | 1.7    | 1.4    | 1.2    |        |        |
| 34.0 |         |        |        |        |        |        |        |        | 1.4    | 1.1    |        |        |        |

\* Nach hinten / \* Over rear / \* A l'arrière / \* Sobre la parte trasera

|    <b>5.1 t</b> <span style="float: right;"><b>DIN/ISO/EN</b></span> |         |        |        |        |        |        |        |        |        |        |        |        |        |
|--|---------|--------|--------|--------|--------|--------|--------|--------|--------|--------|--------|--------|--------|
|  m   | 11.1 m* | 11.1 m | 14.8 m | 18.5 m | 22.1 m | 25.8 m | 29.5 m | 33.2 m | 36.9 m | 40.5 m | 44.2 m | 47.9 m | 51.2 m |
| 2.3  | 100.0   |        |        |        |        |        |        |        |        |        |        |        |        |
| 2.5  | 90.0    |        |        |        |        |        |        |        |        |        |        |        |        |
| 3.0  | 80.2    | 75.2   | 65.0   | 65.0   |        |        |        |        |        |        |        |        |        |
| 3.5  | 72.4    | 68.1   | 65.0   | 65.0   | 50.0   |        |        |        |        |        |        |        |        |
| 4.0  | 66.0    | 62.1   | 61.6   | 61.2   | 50.0   | 41.3   |        |        |        |        |        |        |        |
| 4.5  | 59.4    | 56.9   | 56.4   | 51.5   | 48.6   | 41.3   |        |        |        |        |        |        |        |
| 5.0  | 53.1    | 51.7   | 48.7   | 43.3   | 41.5   | 37.7   | 31.6   |        |        |        |        |        |        |
| 6.0  | 40.8    | 40.8   | 36.0   | 33.5   | 34.1   | 31.9   | 28.5   | 23.8   |        |        |        |        |        |
| 7.0  | 30.6    | 30.6   | 28.1   | 29.3   | 27.7   | 26.0   | 24.1   | 22.3   | 19.7   |        |        |        |        |
| 8.0  | 23.5    | 23.6   | 24.8   | 24.2   | 23.1   | 21.7   | 20.2   | 19.9   | 17.8   | 15.8   |        |        |        |
| 9.0  | 18.8    | 18.8   | 20.0   | 20.5   | 19.6   | 18.5   | 17.7   | 17.0   | 16.1   | 14.6   | 12.9   |        |        |
| 10.0   |         |        | 16.6   | 17.1   | 16.8   | 15.8   | 16.3   | 14.9   | 14.8   | 12.9   | 12.4   | 10.2   |        |
| 11.0   |         |        | 13.9   | 14.5   | 15.1   | 14.6   | 14.3   | 13.6   | 13.0   | 12.3   | 11.0   | 10.2   | 8.9    |
| 12.0   |         |        | 11.8   | 12.4   | 13.0   | 12.9   | 12.6   | 12.0   | 11.5   | 10.9   | 10.3   | 9.6    | 8.9    |
| 14.0   |         |        |        | 9.3    | 9.8    | 9.9    | 10.0   | 9.6    | 9.3    | 8.7    | 8.2    | 7.6    | 7.4    |
| 16.0   |         |        |        | 7.2    | 7.7    | 7.8    | 7.8    | 7.7    | 7.6    | 7.1    | 6.7    | 6.1    | 5.9    |
| 18.0   |         |        |        |        | 6.2    | 6.2    | 6.3    | 6.2    | 6.1    | 5.8    | 5.5    | 4.9    | 4.8    |
| 20.0   |         |        |        |        | 5.1    | 5.1    | 5.2    | 5.0    | 5.0    | 4.7    | 4.5    | 4.0    | 3.9    |
| 22.0   |         |        |        |        |        | 4.2    | 4.3    | 4.1    | 4.1    | 3.8    | 3.7    | 3.3    | 3.2    |
| 24.0   |         |        |        |        |        |        | 3.6    | 3.4    | 3.3    | 3.1    | 2.9    | 2.6    | 2.6    |
| 26.0   |         |        |        |        |        |        |        | 3.0    | 2.8    | 2.5    | 2.4    | 2.0    | 2.0    |
| 28.0   |         |        |        |        |        |        |        |        | 2.3    | 2.3    | 2.0    | 1.9    | 1.5    |
| 30.0   |         |        |        |        |        |        |        |        | 1.9    | 1.8    | 1.6    | 1.4    | 1.1    |
| 32.0   |         |        |        |        |        |        |        |        |        | 1.5    | 1.2    | 1.1    | 1.1    |
| 34.0   |         |        |        |        |        |        |        |        |        |        | 1.2    | 1.1    | 1.1    |

\* Nach hinten / \* Over rear / \* A l'arrière / \* Sobre la parte trasera

|    <b>0 t</b> <span style="float: right;"><b>DIN/ISO/EN</b></span> |         |        |        |        |        |        |        |        |        |        |        |        |        |
|--|---------|--------|--------|--------|--------|--------|--------|--------|--------|--------|--------|--------|--------|
|  m   | 11.1 m* | 11.1 m | 14.8 m | 18.5 m | 22.1 m | 25.8 m | 29.5 m | 33.2 m | 36.9 m | 40.5 m | 44.2 m | 47.9 m | 51.2 m |
| 2.3  | 100.0   |        |        |        |        |        |        |        |        |        |        |        |        |
| 2.5  | 90.0    |        |        |        |        |        |        |        |        |        |        |        |        |
| 3.0  | 79.4    | 74.4   | 65.0   | 65.0   |        |        |        |        |        |        |        |        |        |
| 3.5  | 71.7    | 67.3   | 65.0   | 65.0   | 50.0   |        |        |        |        |        |        |        |        |
| 4.0  | 64.4    | 61.3   | 59.4   | 51.0   | 47.5   | 41.3   |        |        |        |        |        |        |        |
| 4.5  | 55.7    | 55.1   | 47.5   | 42.8   | 39.4   | 35.3   |        |        |        |        |        |        |        |
| 5.0  | 45.6    | 45.6   | 39.3   | 35.9   | 35.0   | 33.4   | 28.8   |        |        |        |        |        |        |
| 6.0  | 32.9    | 32.9   | 29.4   | 29.9   | 28.0   | 25.9   | 23.8   | 21.6   |        |        |        |        |        |
| 7.0  | 24.5    | 24.5   | 24.7   | 23.8   | 22.3   | 20.3   | 20.8   | 18.5   | 16.2   |        |        |        |        |
| 8.0  | 18.6    | 18.7   | 19.7   | 19.1   | 18.8   | 17.9   | 17.1   | 16.1   | 14.8   | 12.9   |        |        |        |
| 9.0  | 14.3    | 14.3   | 15.6   | 15.8   | 15.7   | 15.0   | 14.5   | 13.7   | 13.0   | 12.1   | 11.0   |        |        |
| 10.0   |         |        | 12.6   | 13.3   | 13.4   | 12.8   | 12.4   | 11.8   | 11.2   | 10.4   | 9.8    | 9.0    |        |
| 11.0   |         |        | 10.3   | 11.0   | 11.5   | 11.1   | 10.8   | 10.2   | 9.8    | 9.1    | 8.5    | 7.8    | 7.5    |
| 12.0   |         |        | 8.6    | 9.2    | 9.8    | 9.7    | 9.5    | 9.0    | 8.6    | 8.0    | 7.5    | 6.8    | 6.6    |
| 14.0   |         |        |        | 6.7    | 7.2    | 7.3    | 7.4    | 7.0    | 6.7    | 6.2    | 5.8    | 5.2    | 5.0    |
| 16.0   |         |        |        | 5.1    | 5.6    | 5.6    | 5.7    | 5.6    | 5.4    | 4.9    | 4.5    | 4.0    | 3.9    |
| 18.0   |         |        |        |        | 4.3    | 4.4    | 4.5    | 4.3    | 4.3    | 3.9    | 3.6    | 3.1    | 3.0    |
| 20.0   |         |        |        |        | 3.5    | 3.4    | 3.5    | 3.4    | 3.3    | 3.1    | 2.8    | 2.4    | 2.3    |
| 22.0   |         |        |        |        |        | 2.7    | 2.8    | 2.7    | 2.6    | 2.4    | 2.2    | 1.7    | 1.7    |
| 24.0   |         |        |        |        |        |        | 2.2    | 2.1    | 2.0    | 1.8    | 1.6    | 1.2    | 1.2    |
| 26.0   |         |        |        |        |        |        | 1.8    | 1.6    | 1.6    | 1.3    | 1.2    |        |        |
| 28.0   |         |        |        |        |        |        |        | 1.2    | 1.2    |        |        |        |        |

\* Nach hinten / \* Over rear / \* A l'arrière / \* Sobre la parte trasera

Hubhöhen  
Lifting heights  
Hauteurs de levage  
Alturas de elevación







DIN/ISO/EN

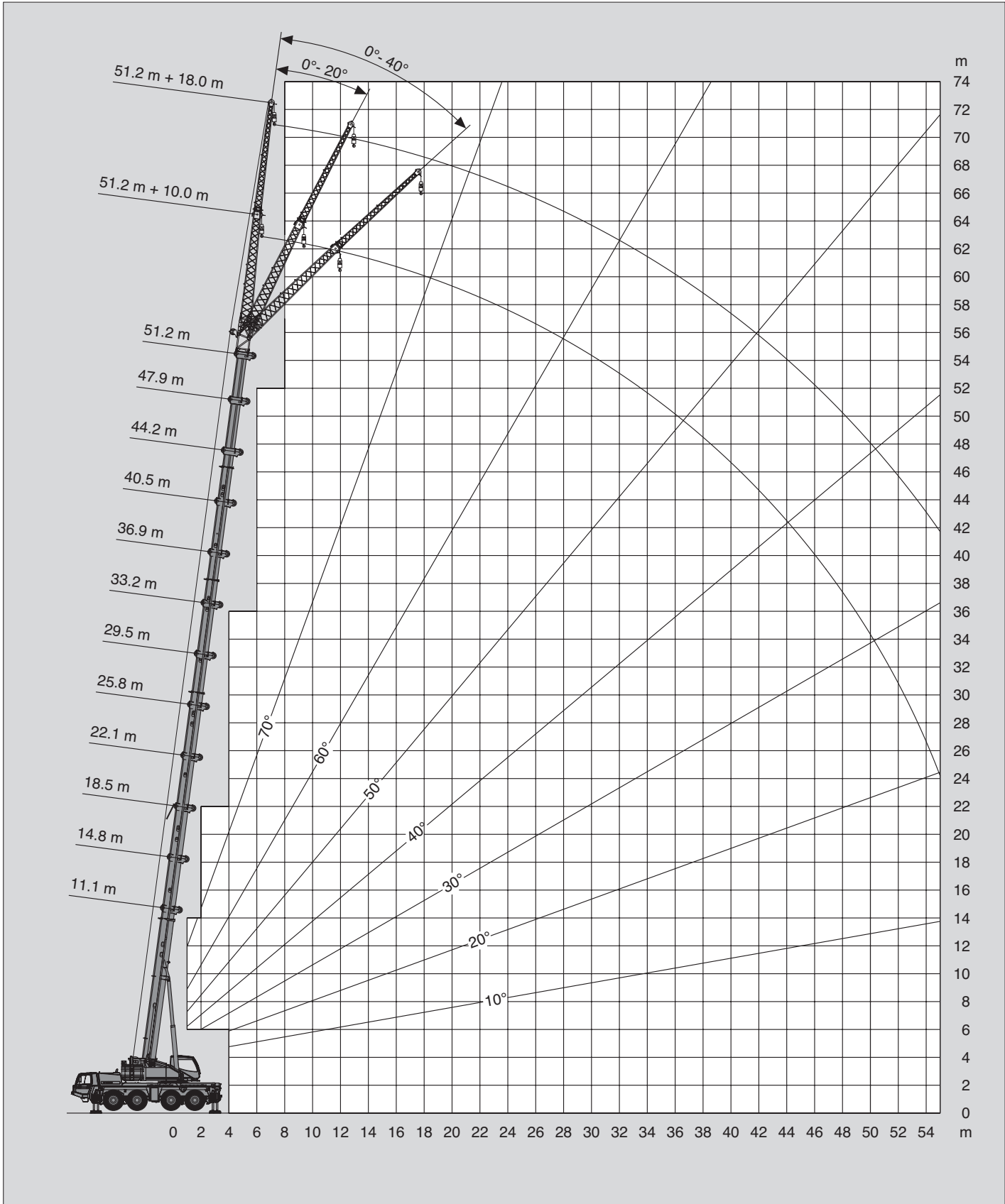









| m    | 11.1 m + 10.0 m |      |     | 33.2 m + 10.0 m |     |     | 40.5 m + 10.0 m |     |     | 44.2 m + 10.0 m |     |     | 47.9 m + 10.0 m |     |     | 51.2 m + 10.0 m |     |     |     |
|------|-----------------|------|-----|-----------------|-----|-----|-----------------|-----|-----|-----------------|-----|-----|-----------------|-----|-----|-----------------|-----|-----|-----|
|      | 0°              | 20°  | 40° | 0°              | 20° | 40° | 0°              | 20° | 40° | 0°              | 20° | 40° | 0°              | 20° | 40° | 0°              | 20° | 40° |     |
| 3.0  | 12.2            |      |     |                 |     |     |                 |     |     |                 |     |     |                 |     |     |                 |     |     |     |
| 3.5  | 12.2            |      |     |                 |     |     |                 |     |     |                 |     |     |                 |     |     |                 |     |     |     |
| 4.0  | 12.2            |      |     |                 |     |     |                 |     |     |                 |     |     |                 |     |     |                 |     |     |     |
| 4.5  | 12.2            |      |     |                 |     |     |                 |     |     |                 |     |     |                 |     |     |                 |     |     |     |
| 5.0  | 12.2            | 12.2 |     |                 |     |     |                 |     |     |                 |     |     |                 |     |     |                 |     |     |     |
| 6.0  | 12.2            | 11.5 |     |                 |     |     |                 |     |     |                 |     |     |                 |     |     |                 |     |     |     |
| 7.0  | 12.2            | 10.8 |     | 10.1            |     |     |                 |     |     |                 |     |     |                 |     |     |                 |     |     |     |
| 8.0  | 12.2            | 10.2 | 8.8 | 10.1            |     |     |                 |     |     |                 |     |     |                 |     |     |                 |     |     |     |
| 9.0  | 12.1            | 9.7  | 8.4 | 10.1            |     |     | 7.7             |     |     |                 |     |     |                 |     |     |                 |     |     |     |
| 10.0 | 11.3            | 9.2  | 8.1 | 10.1            | 9.0 |     | 7.7             |     |     | 6.5             |     |     |                 |     |     |                 |     |     |     |
| 11.0 | 10.6            | 8.8  | 7.9 | 10.1            | 8.6 |     | 7.7             |     |     | 6.5             |     |     |                 |     |     |                 |     |     |     |
| 12.0 | 10.0            | 8.5  | 7.6 | 10.1            | 8.3 |     | 7.7             | 7.6 |     | 6.5             |     |     | 4.9             |     |     |                 |     |     |     |
| 14.0 | 8.9             | 7.9  | 7.3 | 9.3             | 7.6 | 6.7 | 7.7             | 7.0 |     | 6.5             | 6.5 |     | 4.9             |     |     |                 | 4.4 |     |     |
| 16.0 | 8.1             | 7.4  |     | 8.5             | 7.1 | 6.3 | 7.7             | 6.6 | 5.8 | 6.5             | 6.2 | 5.5 | 4.9             | 4.9 |     |                 | 4.4 | 4.4 |     |
| 18.0 |                 |      |     | 7.9             | 6.7 | 6.0 | 7.3             | 6.2 | 5.6 | 6.5             | 5.9 | 5.3 | 4.9             | 4.9 | 4.7 |                 | 4.4 | 4.4 |     |
| 20.0 |                 |      |     | 7.4             | 6.3 | 5.7 | 6.8             | 5.9 | 5.3 | 6.2             | 5.5 | 5.0 | 4.9             | 4.8 | 4.5 | 4.4             | 4.4 | 4.4 | 4.2 |
| 22.0 |                 |      |     | 6.9             | 6.0 | 5.5 | 6.4             | 5.6 | 5.1 | 5.8             | 5.3 | 4.8 | 4.9             | 4.6 | 4.3 | 4.4             | 4.3 | 4.0 | 4.0 |
| 24.0 |                 |      |     | 6.5             | 5.7 | 5.2 | 6.1             | 5.3 | 4.9 | 5.5             | 5.0 | 4.6 | 4.7             | 4.4 | 4.1 | 4.4             | 4.1 | 3.9 | 3.9 |
| 26.0 |                 |      |     | 5.6             | 5.5 | 5.1 | 5.4             | 5.1 | 4.7 | 5.2             | 4.8 | 4.4 | 4.5             | 4.2 | 3.9 | 4.1             | 3.9 | 3.7 | 3.7 |
| 28.0 |                 |      |     | 4.8             | 5.2 | 4.9 | 4.7             | 4.9 | 4.5 | 4.7             | 4.6 | 4.3 | 4.3             | 4.0 | 3.8 | 3.9             | 3.8 | 3.6 | 3.6 |
| 30.0 |                 |      |     | 4.2             | 4.4 | 4.6 | 4.0             | 4.3 | 4.4 | 4.1             | 4.4 | 4.2 | 4.0             | 3.9 | 3.6 | 3.7             | 3.6 | 3.5 | 3.5 |
| 32.0 |                 |      |     | 3.6             | 3.8 | 4.0 | 3.4             | 3.7 | 3.9 | 3.5             | 3.8 | 4.0 | 3.7             | 3.7 | 3.5 | 3.5             | 3.4 | 3.3 | 3.3 |
| 34.0 |                 |      |     | 3.1             | 3.3 |     | 2.9             | 3.2 | 3.4 | 3.0             | 3.3 | 3.5 | 3.2             | 3.5 | 3.4 | 3.2             | 3.3 | 3.2 | 3.2 |
| 36.0 |                 |      |     | 2.7             | 2.8 |     | 2.5             | 2.7 | 2.9 | 2.6             | 2.8 | 3.0 | 2.8             | 3.0 | 3.2 | 2.7             | 3.0 | 3.0 | 3.0 |
| 38.0 |                 |      |     | 2.3             | 2.4 |     | 2.1             | 2.3 | 2.4 | 2.2             | 2.4 | 2.5 | 2.4             | 2.6 | 2.8 | 2.3             | 2.6 | 2.7 | 2.7 |
| 40.0 |                 |      |     | 2.0             |     |     | 1.8             | 1.9 |     | 1.8             | 2.0 | 2.1 | 2.0             | 2.2 | 2.4 | 2.0             | 2.2 | 2.3 | 2.3 |
| 42.0 |                 |      |     |                 |     |     | 1.5             | 1.6 |     | 1.5             | 1.7 | 1.8 | 1.7             | 1.9 | 2.0 | 1.7             | 1.9 | 2.0 | 2.0 |
| 44.0 |                 |      |     |                 |     |     | 1.2             | 1.3 |     | 1.2             | 1.4 |     | 1.4             | 1.6 | 1.7 | 1.4             | 1.6 | 1.7 | 1.7 |
| 46.0 |                 |      |     |                 |     |     | 0.9             | 1.0 |     | 1.0             | 1.1 |     | 1.2             | 1.3 |     | 1.1             | 1.3 | 1.4 | 1.4 |
| 48.0 |                 |      |     |                 |     |     |                 |     |     | 0.8             | 0.9 |     | 1.0             | 1.1 |     | 0.9             | 1.0 | 1.0 | 1.0 |
| 50.0 |                 |      |     |                 |     |     |                 |     |     | 0.6             |     |     | 0.7             | 0.8 |     | 0.7             | 0.8 | 0.8 | 0.8 |
| 52.0 |                 |      |     |                 |     |     |                 |     |     |                 |     |     | 0.6             | 0.6 |     | 0.5             | 0.6 | 0.6 | 0.6 |

| m    | 11.1 m + 18.0 m |     |     | 33.2 m + 18.0 m |     |     | 40.5 m + 18.0 m |     |     | 44.2 m + 18.0 m |     |     | 47.9 m + 18.0 m |     |     | 51.2 m + 18.0 m |     |     |     |
|------|-----------------|-----|-----|-----------------|-----|-----|-----------------|-----|-----|-----------------|-----|-----|-----------------|-----|-----|-----------------|-----|-----|-----|
|      | 0°              | 20° | 40° | 0°              | 20° | 40° | 0°              | 20° | 40° | 0°              | 20° | 40° | 0°              | 20° | 40° | 0°              | 20° | 40° |     |
| 3.5  | 5.8             |     |     |                 |     |     |                 |     |     |                 |     |     |                 |     |     |                 |     |     |     |
| 4.0  | 5.8             |     |     |                 |     |     |                 |     |     |                 |     |     |                 |     |     |                 |     |     |     |
| 4.5  | 5.8             |     |     |                 |     |     |                 |     |     |                 |     |     |                 |     |     |                 |     |     |     |
| 5.0  | 5.8             |     |     |                 |     |     |                 |     |     |                 |     |     |                 |     |     |                 |     |     |     |
| 6.0  | 5.8             |     |     |                 |     |     |                 |     |     |                 |     |     |                 |     |     |                 |     |     |     |
| 7.0  | 5.8             |     |     |                 |     |     |                 |     |     |                 |     |     |                 |     |     |                 |     |     |     |
| 8.0  | 5.8             |     |     |                 |     |     |                 |     |     |                 |     |     |                 |     |     |                 |     |     |     |
| 9.0  | 5.8             |     |     | 4.2             |     |     |                 |     |     |                 |     |     |                 |     |     |                 |     |     |     |
| 10.0 | 5.8             | 5.3 |     | 4.2             |     |     |                 |     |     |                 |     |     |                 |     |     |                 |     |     |     |
| 11.0 | 5.8             | 5.0 |     | 4.2             |     |     |                 |     |     |                 |     |     |                 |     |     |                 |     |     |     |
| 12.0 | 5.7             | 4.8 |     | 4.2             |     |     |                 |     |     |                 |     |     |                 |     |     |                 |     |     |     |
| 14.0 | 5.1             | 4.4 |     | 4.2             |     |     | 3.6             |     |     | 3.3             |     |     |                 |     |     |                 |     |     |     |
| 16.0 | 4.7             | 4.1 | 3.7 | 4.2             | 4.2 |     | 3.6             |     |     | 3.3             |     |     | 2.9             |     |     |                 | 2.7 |     |     |
| 18.0 | 4.3             | 3.8 | 3.5 | 4.2             | 4.1 |     | 3.6             | 3.6 |     | 3.3             |     |     | 2.9             |     |     |                 | 2.7 |     |     |
| 20.0 | 4.0             | 3.5 | 3.3 | 4.2             | 3.9 | 3.4 | 3.6             | 3.6 |     | 3.3             | 3.3 |     | 2.9             | 2.9 |     |                 | 2.7 |     |     |
| 22.0 | 3.7             | 3.4 | 3.2 | 4.2             | 3.8 | 3.3 | 3.6             | 3.6 | 3.3 | 3.3             | 3.3 |     | 2.9             | 2.9 |     |                 | 2.7 | 2.7 |     |
| 24.0 | 3.5             | 3.2 | 3.1 | 4.2             | 3.6 | 3.2 | 3.6             | 3.6 | 3.2 | 3.3             | 3.3 | 3.1 | 2.9             | 2.9 |     |                 | 2.7 | 2.7 |     |
| 26.0 | 3.3             | 3.1 |     | 4.2             | 3.5 | 3.1 | 3.6             | 3.5 | 3.1 | 3.3             | 3.3 | 3.0 | 2.9             | 2.9 | 2.9 |                 | 2.7 | 2.7 | 2.7 |
| 28.0 |                 |     |     | 4.1             | 3.4 | 3.0 | 3.6             | 3.4 | 3.0 | 3.3             | 3.3 | 3.0 | 2.9             | 2.9 | 2.8 |                 | 2.7 | 2.7 | 2.6 |
| 30.0 |                 |     |     | 3.9             | 3.3 | 3.0 | 3.6             | 3.3 | 2.9 | 3.3             | 3.2 | 2.9 | 2.9             | 2.9 | 2.7 |                 | 2.7 | 2.7 | 2.6 |
| 32.0 |                 |     |     | 3.8             | 3.2 | 2.9 | 3.6             | 3.2 | 2.9 | 3.3             | 3.1 | 2.8 | 2.9             | 2.7 | 2.6 |                 | 2.7 | 2.6 | 2.5 |
| 34.0 |                 |     |     | 3.6             | 3.1 | 2.9 | 3.4             | 3.1 | 2.8 | 3.3             | 3.0 | 2.8 | 2.9             | 2.7 | 2.5 |                 | 2.7 | 2.5 | 2.4 |
| 36.0 |                 |     |     | 3.2             | 3.0 | 2.8 | 2.9             | 3.0 | 2.8 | 2.9             | 3.0 | 2.7 | 2.8             | 2.6 | 2.4 |                 | 2.7 | 2.4 | 2.3 |
| 38.0 |                 |     |     | 2.8             | 2.9 | 2.8 | 2.5             | 2.9 | 2.7 | 2.6             | 2.9 | 2.7 | 2.6             | 2.5 | 2.4 |                 | 2.6 | 2.3 | 2.2 |
| 40.0 |                 |     |     | 2.4             | 2.7 | 2.8 | 2.2             | 2.6 | 2.7 | 2.2             | 2.6 | 2.6 | 2.3             | 2.4 | 2.3 |                 | 2.2 | 2.3 | 2.2 |
| 42.0 |                 |     |     | 2.1             | 2.3 |     | 1.9             | 2.2 | 2.4 | 1.9             | 2.2 | 2.5 | 2.0             | 2.3 | 2.2 |                 | 1.9 | 2.2 | 2.1 |
| 44.0 |                 |     |     | 1.8             | 2.0 |     | 1.6             | 1.9 | 2.1 | 1.6             | 1.9 | 2.1 | 1.7             | 2.0 | 2.2 |                 | 1.6 | 2.0 | 2.1 |
| 46.0 |                 |     |     | 1.6             | 1.7 |     | 1.3             | 1.6 | 1.7 | 1.3             | 1.6 | 1.8 | 1.4             | 1.7 | 1.9 |                 | 1.3 | 1.7 | 1.9 |
| 48.0 |                 |     |     | 1.3             |     |     | 1.1             | 1.3 |     | 1.1             | 1.4 | 1.5 | 1.2             | 1.5 | 1.6 |                 | 1.1 | 1.4 | 1.6 |
| 50.0 |                 |     |     |                 |     |     | 0.9             | 1.1 |     | 0.9             | 1.1 | 1.2 | 1.0             | 1.2 | 1.4 |                 | 0.9 | 1.2 | 1.3 |
| 52.0 |                 |     |     |                 |     |     | 0.7             | 0.8 |     | 0.7             | 0.9 |     | 0.8             | 1.0 | 1.1 |                 | 0.7 | 0.9 | 1.1 |
| 54.0 |                 |     |     |                 |     |     | 0.5             | 0.6 |     | 0.5             | 0.7 |     | 0.6             | 0.8 |     |                 | 0.5 | 0.7 | 0.9 |
| 56.0 |                 |     |     |                 |     |     |                 |     |     |                 |     |     | 0.5             | 0.6 |     |                 | 0.5 | 0.5 | 0.5 |

Tragfähigkeiten  
Lifting capacities  
Capacités de levage  
Capacidades de elevación

|  <span style="float: right; border: 1px solid black; padding: 2px;">DIN/ISO/EN</span> |                 |      |     |                 |     |     |                 |     |     |                 |     |     |                 |     |     |                 |     |     |
|---|-----------------|------|-----|-----------------|-----|-----|-----------------|-----|-----|-----------------|-----|-----|-----------------|-----|-----|-----------------|-----|-----|
| <br>m   | 11.1 m + 10.0 m |      |     | 33.2 m + 10.0 m |     |     | 40.5 m + 10.0 m |     |     | 44.2 m + 10.0 m |     |     | 47.9 m + 10.0 m |     |     | 51.2 m + 10.0 m |     |     |
|   | 0°              | 20°  | 40° | 0°              | 20° | 40° | 0°              | 20° | 40° | 0°              | 20° | 40° | 0°              | 20° | 40° | 0°              | 20° | 40° |
| 3.0   | 12.2            |      |     |                 |     |     |                 |     |     |                 |     |     |                 |     |     |                 |     |     |
| 3.5   | 12.2            |      |     |                 |     |     |                 |     |     |                 |     |     |                 |     |     |                 |     |     |
| 4.0   | 12.2            |      |     |                 |     |     |                 |     |     |                 |     |     |                 |     |     |                 |     |     |
| 4.5   | 12.2            |      |     |                 |     |     |                 |     |     |                 |     |     |                 |     |     |                 |     |     |
| 5.0   | 12.2            | 12.2 |     |                 |     |     |                 |     |     |                 |     |     |                 |     |     |                 |     |     |
| 6.0   | 12.2            | 11.5 |     |                 |     |     |                 |     |     |                 |     |     |                 |     |     |                 |     |     |
| 7.0   | 12.2            | 10.8 |     | 10.1            |     |     |                 |     |     |                 |     |     |                 |     |     |                 |     |     |
| 8.0   | 12.2            | 10.2 | 8.8 | 10.1            |     |     |                 |     |     |                 |     |     |                 |     |     |                 |     |     |
| 9.0   | 12.1            | 9.7  | 8.4 | 10.1            |     |     | 7.7             |     |     |                 |     |     |                 |     |     |                 |     |     |
| 10.0  | 11.3            | 9.2  | 8.1 | 10.1            | 9.0 |     | 7.7             |     |     | 6.5             |     |     |                 |     |     |                 |     |     |
| 11.0  | 10.6            | 8.8  | 7.9 | 10.1            | 8.6 |     | 7.7             |     |     | 6.5             |     |     |                 |     |     |                 |     |     |
| 12.0  | 10.0            | 8.5  | 7.6 | 10.1            | 8.3 |     | 7.7             | 7.6 |     | 6.5             |     |     | 4.9             |     |     |                 |     |     |
| 14.0  | 8.9             | 7.9  | 7.3 | 9.3             | 7.6 | 6.7 | 7.7             | 7.0 |     | 6.5             | 6.5 |     | 4.9             |     |     | 4.4             |     |     |
| 16.0  | 8.1             | 7.4  |     | 8.5             | 7.1 | 6.3 | 7.7             | 6.6 | 5.8 | 6.5             | 6.2 | 5.5 | 4.9             | 4.9 |     | 4.4             | 4.4 |     |
| 18.0  |                 |      |     | 7.9             | 6.7 | 6.0 | 7.3             | 6.2 | 5.6 | 6.5             | 5.9 | 5.3 | 4.9             | 4.9 | 4.7 | 4.4             | 4.4 |     |
| 20.0  |                 |      |     | 7.4             | 6.3 | 5.7 | 6.8             | 5.9 | 5.3 | 6.2             | 5.5 | 5.0 | 4.9             | 4.8 | 4.5 | 4.4             | 4.4 | 4.2 |
| 22.0  |                 |      |     | 6.1             | 6.0 | 5.5 | 5.9             | 5.6 | 5.1 | 5.8             | 5.3 | 4.8 | 4.9             | 4.6 | 4.3 | 4.4             | 4.3 | 4.0 |
| 24.0  |                 |      |     | 5.2             | 5.6 | 5.2 | 5.0             | 5.3 | 4.9 | 5.0             | 5.0 | 4.6 | 4.7             | 4.4 | 4.1 | 4.4             | 4.1 | 3.9 |
| 26.0  |                 |      |     | 4.3             | 4.7 | 5.0 | 4.2             | 4.6 | 4.7 | 4.2             | 4.7 | 4.4 | 4.4             | 4.2 | 3.9 | 4.1             | 3.9 | 3.7 |
| 28.0  |                 |      |     | 3.6             | 4.0 | 4.2 | 3.5             | 3.8 | 4.1 | 3.5             | 3.9 | 4.2 | 3.8             | 4.0 | 3.8 | 3.7             | 3.8 | 3.6 |
| 30.0  |                 |      |     | 3.0             | 3.3 | 3.5 | 2.9             | 3.2 | 3.5 | 2.9             | 3.3 | 3.6 | 3.2             | 3.6 | 3.6 | 3.1             | 3.5 | 3.5 |
| 32.0  |                 |      |     | 2.5             | 2.8 | 2.9 | 2.4             | 2.7 | 2.9 | 2.4             | 2.7 | 3.0 | 2.7             | 3.0 | 3.2 | 2.6             | 3.0 | 3.2 |
| 34.0  |                 |      |     | 2.1             | 2.3 |     | 1.9             | 2.2 | 2.4 | 2.0             | 2.3 | 2.5 | 2.2             | 2.5 | 2.7 | 2.2             | 2.5 | 2.7 |
| 36.0  |                 |      |     | 1.7             | 1.9 |     | 1.5             | 1.8 | 1.9 | 1.6             | 1.9 | 2.0 | 1.8             | 2.1 | 2.3 | 1.8             | 2.1 | 2.3 |
| 38.0  |                 |      |     | 1.4             | 1.5 |     | 1.2             | 1.4 | 1.5 | 1.3             | 1.5 | 1.6 | 1.5             | 1.7 | 1.9 | 1.4             | 1.7 | 1.9 |
| 40.0  |                 |      |     | 1.1             |     |     | 0.9             | 1.1 |     | 1.0             | 1.2 | 1.3 | 1.2             | 1.4 | 1.5 | 1.1             | 1.4 | 1.5 |
| 42.0  |                 |      |     |                 |     |     | 0.6             | 0.8 |     | 0.7             | 0.9 | 1.0 | 0.9             | 1.1 | 1.2 | 0.9             | 1.1 | 1.2 |
| 44.0  |                 |      |     |                 |     |     |                 | 0.5 |     | 0.5             | 0.6 |     | 0.7             | 0.8 | 0.9 | 0.6             | 0.8 | 0.9 |
| 46.0  |                 |      |     |                 |     |     |                 |     |     |                 |     |     | 0.6             |     |     |                 | 0.5 | 0.6 |

|  <span style="float: right; border: 1px solid black; padding: 2px;">DIN/ISO/EN</span> |                 |     |     |                 |     |     |                 |     |     |                 |     |     |                 |     |     |                 |     |     |
|---|-----------------|-----|-----|-----------------|-----|-----|-----------------|-----|-----|-----------------|-----|-----|-----------------|-----|-----|-----------------|-----|-----|
| <br>m   | 11.1 m + 18.0 m |     |     | 33.2 m + 18.0 m |     |     | 40.5 m + 18.0 m |     |     | 44.2 m + 18.0 m |     |     | 47.9 m + 18.0 m |     |     | 51.2 m + 18.0 m |     |     |
|   | 0°              | 20° | 40° | 0°              | 20° | 40° | 0°              | 20° | 40° | 0°              | 20° | 40° | 0°              | 20° | 40° | 0°              | 20° | 40° |
| 3.5   | 5.8             |     |     |                 |     |     |                 |     |     |                 |     |     |                 |     |     |                 |     |     |
| 4.0   | 5.8             |     |     |                 |     |     |                 |     |     |                 |     |     |                 |     |     |                 |     |     |
| 4.5   | 5.8             |     |     |                 |     |     |                 |     |     |                 |     |     |                 |     |     |                 |     |     |
| 5.0   | 5.8             |     |     |                 |     |     |                 |     |     |                 |     |     |                 |     |     |                 |     |     |
| 6.0   | 5.8             |     |     |                 |     |     |                 |     |     |                 |     |     |                 |     |     |                 |     |     |
| 7.0   | 5.8             |     |     |                 |     |     |                 |     |     |                 |     |     |                 |     |     |                 |     |     |
| 8.0   | 5.8             |     |     |                 |     |     |                 |     |     |                 |     |     |                 |     |     |                 |     |     |
| 9.0   | 5.8             |     |     | 4.2             |     |     |                 |     |     |                 |     |     |                 |     |     |                 |     |     |
| 10.0  | 5.8             | 5.3 |     | 4.2             |     |     |                 |     |     |                 |     |     |                 |     |     |                 |     |     |
| 11.0  | 5.8             | 5.0 |     | 4.2             |     |     |                 |     |     |                 |     |     |                 |     |     |                 |     |     |
| 12.0  | 5.7             | 4.8 |     | 4.2             |     |     |                 |     |     |                 |     |     |                 |     |     |                 |     |     |
| 14.0  | 5.1             | 4.4 |     | 4.2             |     |     | 3.6             |     |     | 3.3             |     |     |                 |     |     |                 |     |     |
| 16.0  | 4.7             | 4.1 | 3.7 | 4.2             | 4.2 |     | 3.6             |     |     | 3.3             |     |     | 2.9             |     |     | 2.7             |     |     |
| 18.0  | 4.3             | 3.8 | 3.5 | 4.2             | 4.1 |     | 3.6             | 3.6 |     | 3.3             |     |     | 2.9             |     |     | 2.7             |     |     |
| 20.0  | 4.0             | 3.5 | 3.3 | 4.2             | 3.9 | 3.4 | 3.6             | 3.6 |     | 3.3             | 3.3 |     | 2.9             | 2.9 |     | 2.7             |     |     |
| 22.0  | 3.7             | 3.4 | 3.2 | 4.2             | 3.8 | 3.3 | 3.6             | 3.6 | 3.3 | 3.3             | 3.3 |     | 2.9             | 2.9 |     | 2.7             | 2.7 |     |
| 24.0  | 3.5             | 3.2 | 3.1 | 4.2             | 3.6 | 3.2 | 3.6             | 3.6 | 3.2 | 3.3             | 3.3 | 3.1 | 2.9             | 2.9 |     | 2.7             | 2.7 |     |
| 26.0  | 3.3             | 3.1 |     | 4.2             | 3.5 | 3.1 | 3.6             | 3.5 | 3.1 | 3.3             | 3.3 | 3.0 | 2.9             | 2.9 | 2.9 | 2.7             | 2.7 | 2.7 |
| 28.0  |                 |     |     | 4.1             | 3.4 | 3.0 | 3.6             | 3.4 | 3.0 | 3.3             | 3.3 | 3.0 | 2.9             | 2.9 | 2.8 | 2.7             | 2.7 | 2.6 |
| 30.0  |                 |     |     | 3.6             | 3.3 | 3.0 | 3.4             | 3.3 | 2.9 | 3.3             | 3.2 | 2.9 | 2.9             | 2.9 | 2.7 | 2.7             | 2.7 | 2.6 |
| 32.0  |                 |     |     | 3.1             | 3.2 | 2.9 | 2.8             | 3.2 | 2.9 | 2.9             | 3.1 | 2.8 | 2.9             | 2.7 | 2.6 | 2.7             | 2.6 | 2.5 |
| 34.0  |                 |     |     | 2.6             | 3.1 | 2.9 | 2.4             | 2.9 | 2.8 | 2.4             | 3.0 | 2.8 | 2.5             | 2.7 | 2.5 | 2.4             | 2.5 | 2.4 |
| 36.0  |                 |     |     | 2.2             | 2.6 | 2.8 | 2.0             | 2.5 | 2.8 | 2.0             | 2.5 | 2.7 | 2.1             | 2.6 | 2.4 | 2.0             | 2.4 | 2.3 |
| 38.0  |                 |     |     | 1.9             | 2.2 | 2.5 | 1.6             | 2.1 | 2.4 | 1.7             | 2.1 | 2.5 | 1.8             | 2.2 | 2.4 | 1.7             | 2.1 | 2.2 |
| 40.0  |                 |     |     | 1.6             | 1.9 | 2.0 | 1.3             | 1.7 | 2.0 | 1.4             | 1.8 | 2.1 | 1.4             | 1.9 | 2.2 | 1.4             | 1.8 | 2.1 |
| 42.0  |                 |     |     | 1.3             | 1.5 |     | 1.1             | 1.4 | 1.6 | 1.1             | 1.4 | 1.7 | 1.2             | 1.5 | 1.8 | 1.1             | 1.5 | 1.8 |
| 44.0  |                 |     |     | 1.0             | 1.2 |     | 0.8             | 1.1 | 1.3 | 0.8             | 1.2 | 1.4 | 0.9             | 1.3 | 1.5 | 0.8             | 1.2 | 1.5 |
| 46.0  |                 |     |     | 0.8             | 1.0 |     | 0.6             | 0.8 | 1.0 | 0.6             | 0.9 | 1.1 | 0.7             | 1.0 | 1.2 | 0.6             | 0.9 | 1.2 |
| 48.0  |                 |     |     | 0.6             |     |     |                 | 0.6 |     |                 | 0.7 | 0.8 | 0.5             | 0.8 | 0.9 |                 | 0.7 | 0.9 |
| 50.0  |                 |     |     |                 |     |     |                 |     |     |                 |     | 0.6 |                 | 0.5 | 0.7 |                 |     | 0.7 |
| 52.0  |                 |     |     |                 |     |     |                 |     |     |                 |     |     |                 |     | 0.5 |                 |     |     |







10.2t

DIN/ISO/EN

| m    | 11.1 m + 10.0 m |      |     | 33.2 m + 10.0 m |     |     | 40.5 m + 10.0 m |     |     | 44.2 m + 10.0 m |     |     | 47.9 m + 10.0 m |     |     | 51.2 m + 10.0 m |     |     |
|------|-----------------|------|-----|-----------------|-----|-----|-----------------|-----|-----|-----------------|-----|-----|-----------------|-----|-----|-----------------|-----|-----|
|      | 0°              | 20°  | 40° | 0°              | 20° | 40° | 0°              | 20° | 40° | 0°              | 20° | 40° | 0°              | 20° | 40° | 0°              | 20° | 40° |
| 3.0  | 12.2            |      |     |                 |     |     |                 |     |     |                 |     |     |                 |     |     |                 |     |     |
| 3.5  | 12.2            |      |     |                 |     |     |                 |     |     |                 |     |     |                 |     |     |                 |     |     |
| 4.0  | 12.2            |      |     |                 |     |     |                 |     |     |                 |     |     |                 |     |     |                 |     |     |
| 4.5  | 12.2            |      |     |                 |     |     |                 |     |     |                 |     |     |                 |     |     |                 |     |     |
| 5.0  | 12.2            | 12.2 |     |                 |     |     |                 |     |     |                 |     |     |                 |     |     |                 |     |     |
| 6.0  | 12.2            | 11.5 |     |                 |     |     |                 |     |     |                 |     |     |                 |     |     |                 |     |     |
| 7.0  | 12.2            | 10.8 |     | 10.1            |     |     |                 |     |     |                 |     |     |                 |     |     |                 |     |     |
| 8.0  | 12.2            | 10.2 | 8.8 | 10.1            |     |     |                 |     |     |                 |     |     |                 |     |     |                 |     |     |
| 9.0  | 12.1            | 9.7  | 8.4 | 10.1            |     |     | 7.7             |     |     |                 |     |     |                 |     |     |                 |     |     |
| 10.0 | 11.3            | 9.2  | 8.1 | 10.1            | 9.0 |     | 7.7             |     |     | 6.5             |     |     |                 |     |     |                 |     |     |
| 11.0 | 10.6            | 8.8  | 7.9 | 10.1            | 8.6 |     | 7.7             |     |     | 6.5             |     |     |                 |     |     |                 |     |     |
| 12.0 | 10.0            | 8.5  | 7.6 | 10.1            | 8.3 |     | 7.7             | 7.6 |     | 6.5             |     |     | 4.9             |     |     |                 |     |     |
| 14.0 | 8.9             | 7.9  | 7.3 | 9.3             | 7.6 | 6.7 | 7.7             | 7.0 |     | 6.5             | 6.5 |     | 4.9             |     |     | 4.4             |     |     |
| 16.0 | 8.1             | 7.4  |     | 8.1             | 7.1 | 6.3 | 7.4             | 6.6 | 5.8 | 6.5             | 6.2 | 5.5 | 4.9             | 4.9 |     | 4.4             | 4.4 |     |
| 18.0 |                 |      |     | 6.6             | 6.7 | 6.0 | 6.1             | 6.2 | 5.6 | 6.0             | 5.9 | 5.3 | 4.9             | 4.9 | 4.7 | 4.4             | 4.4 |     |
| 20.0 |                 |      |     | 5.5             | 6.1 | 5.7 | 5.0             | 5.6 | 5.3 | 5.0             | 5.5 | 5.0 | 4.9             | 4.8 | 4.5 | 4.4             | 4.4 | 4.2 |
| 22.0 |                 |      |     | 4.5             | 5.0 | 5.4 | 4.1             | 4.7 | 5.1 | 4.1             | 4.7 | 4.8 | 4.3             | 4.6 | 4.3 | 4.1             | 4.3 | 4.0 |
| 24.0 |                 |      |     | 3.6             | 4.1 | 4.4 | 3.4             | 3.9 | 4.3 | 3.4             | 3.9 | 4.3 | 3.6             | 4.0 | 4.1 | 3.4             | 3.9 | 3.9 |
| 26.0 |                 |      |     | 2.9             | 3.3 | 3.6 | 2.7             | 3.2 | 3.5 | 2.8             | 3.2 | 3.6 | 3.0             | 3.4 | 3.7 | 2.8             | 3.2 | 3.6 |
| 28.0 |                 |      |     | 2.3             | 2.7 | 2.9 | 2.1             | 2.5 | 2.8 | 2.2             | 2.6 | 2.9 | 2.4             | 2.8 | 3.1 | 2.3             | 2.7 | 3.0 |
| 30.0 |                 |      |     | 1.8             | 2.1 | 2.3 | 1.7             | 2.0 | 2.2 | 1.7             | 2.1 | 2.3 | 2.0             | 2.3 | 2.6 | 1.9             | 2.2 | 2.5 |
| 32.0 |                 |      |     | 1.4             | 1.7 | 1.8 | 1.2             | 1.5 | 1.7 | 1.3             | 1.6 | 1.9 | 1.6             | 1.9 | 2.1 | 1.5             | 1.8 | 2.0 |
| 34.0 |                 |      |     | 1.0             | 1.2 |     | 0.9             | 1.1 | 1.3 | 0.9             | 1.2 | 1.4 | 1.2             | 1.5 | 1.7 | 1.1             | 1.4 | 1.6 |
| 36.0 |                 |      |     | 0.7             | 0.9 |     | 0.6             | 0.8 | 0.9 | 0.6             | 0.9 | 1.0 | 0.9             | 1.1 | 1.3 | 0.8             | 1.1 | 1.3 |
| 38.0 |                 |      |     | 0.5             | 0.6 |     |                 | 0.5 | 0.6 |                 |     | 0.6 | 0.7             |     | 0.8 | 1.0             |     | 0.9 |
| 40.0 |                 |      |     |                 |     |     |                 |     |     |                 |     |     |                 |     | 0.7 |                 |     |     |











10.2t

DIN/ISO/EN

| m    | 11.1 m + 18.0 m |     |     | 33.2 m + 18.0 m |     |     | 40.5 m + 18.0 m |     |     | 44.2 m + 18.0 m |     |     | 47.9 m + 18.0 m |     |     | 51.2 m + 18.0 m |     |     |
|------|-----------------|-----|-----|-----------------|-----|-----|-----------------|-----|-----|-----------------|-----|-----|-----------------|-----|-----|-----------------|-----|-----|
|      | 0°              | 20° | 40° | 0°              | 20° | 40° | 0°              | 20° | 40° | 0°              | 20° | 40° | 0°              | 20° | 40° | 0°              | 20° | 40° |
| 3.5  | 5.8             |     |     |                 |     |     |                 |     |     |                 |     |     |                 |     |     |                 |     |     |
| 4.0  | 5.8             |     |     |                 |     |     |                 |     |     |                 |     |     |                 |     |     |                 |     |     |
| 4.5  | 5.8             |     |     |                 |     |     |                 |     |     |                 |     |     |                 |     |     |                 |     |     |
| 5.0  | 5.8             |     |     |                 |     |     |                 |     |     |                 |     |     |                 |     |     |                 |     |     |
| 6.0  | 5.8             |     |     |                 |     |     |                 |     |     |                 |     |     |                 |     |     |                 |     |     |
| 7.0  | 5.8             |     |     |                 |     |     |                 |     |     |                 |     |     |                 |     |     |                 |     |     |
| 8.0  | 5.8             |     |     |                 |     |     |                 |     |     |                 |     |     |                 |     |     |                 |     |     |
| 9.0  | 5.8             |     |     | 4.2             |     |     |                 |     |     |                 |     |     |                 |     |     |                 |     |     |
| 10.0 | 5.8             | 5.3 |     | 4.2             |     |     |                 |     |     |                 |     |     |                 |     |     |                 |     |     |
| 11.0 | 5.8             | 5.0 |     | 4.2             |     |     |                 |     |     |                 |     |     |                 |     |     |                 |     |     |
| 12.0 | 5.7             | 4.8 |     | 4.2             |     |     |                 |     |     |                 |     |     |                 |     |     |                 |     |     |
| 14.0 | 5.1             | 4.4 |     | 4.2             |     |     | 3.6             |     |     | 3.3             |     |     |                 |     |     |                 |     |     |
| 16.0 | 4.7             | 4.1 | 3.7 | 4.2             | 4.2 |     | 3.6             |     |     | 3.3             |     |     | 2.9             |     |     | 2.7             |     |     |
| 18.0 | 4.3             | 3.8 | 3.5 | 4.2             | 4.1 |     | 3.6             | 3.6 |     | 3.3             |     |     | 2.9             |     |     | 2.7             |     |     |
| 20.0 | 4.0             | 3.5 | 3.3 | 4.2             | 3.9 | 3.4 | 3.6             | 3.6 |     | 3.3             | 3.3 |     | 2.9             | 2.9 |     | 2.7             |     |     |
| 22.0 | 3.7             | 3.4 | 3.2 | 4.2             | 3.8 | 3.3 | 3.6             | 3.6 | 3.3 | 3.3             | 3.3 |     | 2.9             | 2.9 |     | 2.7             | 2.7 |     |
| 24.0 | 3.5             | 3.2 | 3.1 | 4.2             | 3.6 | 3.2 | 3.6             | 3.6 | 3.2 | 3.3             | 3.3 | 3.1 | 2.9             | 2.9 |     | 2.7             | 2.7 |     |
| 26.0 | 3.3             | 3.1 |     | 3.5             | 3.5 | 3.1 | 3.1             | 3.5 | 3.1 | 3.1             | 3.3 | 3.0 | 2.9             | 2.9 | 2.9 | 2.7             | 2.7 | 2.7 |
| 28.0 |                 |     |     | 2.9             | 3.4 | 3.0 | 2.6             | 3.3 | 3.0 | 2.6             | 3.3 | 3.0 | 2.6             | 2.9 | 2.8 | 2.4             | 2.7 | 2.6 |
| 30.0 |                 |     |     | 2.4             | 3.0 | 3.0 | 2.1             | 2.8 | 2.9 | 2.1             | 2.7 | 2.9 | 2.2             | 2.8 | 2.7 | 2.0             | 2.7 | 2.6 |
| 32.0 |                 |     |     | 1.9             | 2.5 | 2.9 | 1.7             | 2.3 | 2.8 | 1.7             | 2.3 | 2.8 | 1.8             | 2.3 | 2.6 | 1.6             | 2.2 | 2.5 |
| 34.0 |                 |     |     | 1.6             | 2.0 | 2.4 | 1.3             | 1.9 | 2.3 | 1.4             | 1.9 | 2.3 | 1.4             | 2.0 | 2.4 | 1.3             | 1.8 | 2.3 |
| 36.0 |                 |     |     | 1.2             | 1.6 | 1.9 | 1.0             | 1.5 | 1.8 | 1.0             | 1.5 | 1.9 | 1.1             | 1.6 | 2.0 | 1.0             | 1.5 | 1.9 |
| 38.0 |                 |     |     | 0.9             | 1.3 | 1.5 | 0.7             | 1.1 | 1.5 | 0.7             | 1.2 | 1.5 | 0.8             | 1.3 | 1.6 |                 | 1.2 | 1.6 |
| 40.0 |                 |     |     | 0.7             | 1.0 | 1.2 |                 | 0.8 | 1.1 |                 |     | 0.9 | 1.2             |     | 1.3 |                 | 0.9 | 1.2 |
| 42.0 |                 |     |     | 0.5             | 0.7 |     |                 | 0.6 | 0.8 |                 |     |     | 0.9             |     | 1.0 |                 |     | 0.9 |
| 44.0 |                 |     |     |                 | 0.5 |     |                 |     |     |                 |     |     |                 |     | 0.7 |                 |     |     |

Tragfähigkeiten  
Lifting capacities  
Capacités de levage  
Capacidades de elevación

|  <span style="float: right; border: 1px solid black; padding: 2px;">DIN/ISO/EN</span> |                 |      |     |                 |     |     |                 |     |     |                 |     |     |                 |     |     |                 |     |     |
|---|-----------------|------|-----|-----------------|-----|-----|-----------------|-----|-----|-----------------|-----|-----|-----------------|-----|-----|-----------------|-----|-----|
| <br>m   | 11.1 m + 10.0 m |      |     | 33.2 m + 10.0 m |     |     | 40.5 m + 10.0 m |     |     | 44.2 m + 10.0 m |     |     | 47.9 m + 10.0 m |     |     | 51.2 m + 10.0 m |     |     |
|   | 0°              | 20°  | 40° | 0°              | 20° | 40° | 0°              | 20° | 40° | 0°              | 20° | 40° | 0°              | 20° | 40° | 0°              | 20° | 40° |
| 3.0   | 12.2            |      |     |                 |     |     |                 |     |     |                 |     |     |                 |     |     |                 |     |     |
| 3.5   | 12.2            |      |     |                 |     |     |                 |     |     |                 |     |     |                 |     |     |                 |     |     |
| 4.0   | 12.2            |      |     |                 |     |     |                 |     |     |                 |     |     |                 |     |     |                 |     |     |
| 4.5   | 12.2            |      |     |                 |     |     |                 |     |     |                 |     |     |                 |     |     |                 |     |     |
| 5.0   | 12.2            | 12.2 |     |                 |     |     |                 |     |     |                 |     |     |                 |     |     |                 |     |     |
| 6.0   | 12.2            | 11.5 |     |                 |     |     |                 |     |     |                 |     |     |                 |     |     |                 |     |     |
| 7.0   | 12.2            | 10.8 |     | 10.1            |     |     |                 |     |     |                 |     |     |                 |     |     |                 |     |     |
| 8.0   | 12.2            | 10.2 | 8.8 | 10.1            |     |     |                 |     |     |                 |     |     |                 |     |     |                 |     |     |
| 9.0   | 12.1            | 9.7  | 8.4 | 10.1            |     |     | 7.7             |     |     |                 |     |     |                 |     |     |                 |     |     |
| 10.0  | 11.3            | 9.2  | 8.1 | 10.1            | 9.0 |     | 7.7             |     |     | 6.5             |     |     |                 |     |     |                 |     |     |
| 11.0  | 10.6            | 8.8  | 7.9 | 10.1            | 8.6 |     | 7.7             |     |     | 6.5             |     |     |                 |     |     |                 |     |     |
| 12.0  | 10.0            | 8.5  | 7.6 | 10.1            | 8.3 |     | 7.7             | 7.6 |     | 6.5             |     |     | 4.9             |     |     |                 |     |     |
| 14.0  | 8.9             | 7.9  | 7.3 | 7.9             | 7.6 | 6.7 | 7.2             | 7.0 |     | 6.5             | 6.5 |     | 4.9             |     |     | 4.4             |     |     |
| 16.0  | 8.1             | 7.4  |     | 6.3             | 7.1 | 6.3 | 5.7             | 6.5 | 5.8 | 5.7             | 6.2 | 5.5 | 4.9             | 4.9 |     | 4.4             | 4.4 |     |
| 18.0  |                 |      |     | 5.1             | 5.7 | 6.0 | 4.6             | 5.3 | 5.6 | 4.5             | 5.2 | 5.3 | 4.7             | 4.9 | 4.7 | 4.4             | 4.4 |     |
| 20.0  |                 |      |     | 4.1             | 4.7 | 5.2 | 3.7             | 4.3 | 4.8 | 3.6             | 4.2 | 4.8 | 3.8             | 4.4 | 4.5 | 3.6             | 4.2 | 4.2 |
| 22.0  |                 |      |     | 3.3             | 3.8 | 4.2 | 2.9             | 3.4 | 3.9 | 2.9             | 3.4 | 3.9 | 3.1             | 3.6 | 4.0 | 2.9             | 3.4 | 3.9 |
| 24.0  |                 |      |     | 2.5             | 3.0 | 3.3 | 2.3             | 2.7 | 3.1 | 2.3             | 2.8 | 3.2 | 2.5             | 2.9 | 3.3 | 2.3             | 2.8 | 3.2 |
| 26.0  |                 |      |     | 1.9             | 2.3 | 2.6 | 1.7             | 2.2 | 2.5 | 1.8             | 2.2 | 2.5 | 1.9             | 2.3 | 2.7 | 1.8             | 2.2 | 2.6 |
| 28.0  |                 |      |     | 1.4             | 1.8 | 2.0 | 1.2             | 1.6 | 1.9 | 1.3             | 1.7 | 2.0 | 1.5             | 1.9 | 2.2 | 1.4             | 1.7 | 2.1 |
| 30.0  |                 |      |     | 1.0             | 1.3 | 1.5 | 0.8             | 1.2 | 1.4 | 0.9             | 1.3 | 1.5 | 1.1             | 1.4 | 1.7 |                 | 1.3 | 1.6 |
| 32.0  |                 |      |     | 0.6             | 0.9 | 1.0 |                 | 0.8 | 1.0 |                 | 0.8 | 1.1 |                 | 1.1 | 1.3 |                 |     | 1.2 |
| 34.0  |                 |      |     |                 | 0.5 |     |                 |     |     |                 |     |     |                 | 0.9 |     |                 |     |     |

|  <span style="float: right; border: 1px solid black; padding: 2px;">DIN/ISO/EN</span> |                 |     |     |                 |     |     |                 |     |     |                 |     |     |                 |     |     |                 |     |     |
|---|-----------------|-----|-----|-----------------|-----|-----|-----------------|-----|-----|-----------------|-----|-----|-----------------|-----|-----|-----------------|-----|-----|
| <br>m   | 11.1 m + 18.0 m |     |     | 33.2 m + 18.0 m |     |     | 40.5 m + 18.0 m |     |     | 44.2 m + 18.0 m |     |     | 47.9 m + 18.0 m |     |     | 51.2 m + 18.0 m |     |     |
|   | 0°              | 20° | 40° | 0°              | 20° | 40° | 0°              | 20° | 40° | 0°              | 20° | 40° | 0°              | 20° | 40° | 0°              | 20° | 40° |
| 3.5   | 5.8             |     |     |                 |     |     |                 |     |     |                 |     |     |                 |     |     |                 |     |     |
| 4.0   | 5.8             |     |     |                 |     |     |                 |     |     |                 |     |     |                 |     |     |                 |     |     |
| 4.5   | 5.8             |     |     |                 |     |     |                 |     |     |                 |     |     |                 |     |     |                 |     |     |
| 5.0   | 5.8             |     |     |                 |     |     |                 |     |     |                 |     |     |                 |     |     |                 |     |     |
| 6.0   | 5.8             |     |     |                 |     |     |                 |     |     |                 |     |     |                 |     |     |                 |     |     |
| 7.0   | 5.8             |     |     |                 |     |     |                 |     |     |                 |     |     |                 |     |     |                 |     |     |
| 8.0   | 5.8             |     |     |                 |     |     |                 |     |     |                 |     |     |                 |     |     |                 |     |     |
| 9.0   | 5.8             |     |     | 4.2             |     |     |                 |     |     |                 |     |     |                 |     |     |                 |     |     |
| 10.0  | 5.8             | 5.3 |     | 4.2             |     |     |                 |     |     |                 |     |     |                 |     |     |                 |     |     |
| 11.0  | 5.8             | 5.0 |     | 4.2             |     |     |                 |     |     |                 |     |     |                 |     |     |                 |     |     |
| 12.0  | 5.7             | 4.8 |     | 4.2             |     |     |                 |     |     |                 |     |     |                 |     |     |                 |     |     |
| 14.0  | 5.1             | 4.4 |     | 4.2             |     |     | 3.6             |     |     | 3.3             |     |     |                 |     |     |                 |     |     |
| 16.0  | 4.7             | 4.1 | 3.7 | 4.2             | 4.2 |     | 3.6             |     |     | 3.3             |     |     | 2.9             |     |     | 2.7             |     |     |
| 18.0  | 4.3             | 3.8 | 3.5 | 4.2             | 4.1 |     | 3.6             | 3.6 |     | 3.3             |     |     | 2.9             |     |     | 2.7             |     |     |
| 20.0  | 4.0             | 3.5 | 3.3 | 4.2             | 3.9 | 3.4 | 3.6             | 3.6 |     | 3.3             | 3.3 |     | 2.9             | 2.9 |     | 2.7             |     |     |
| 22.0  | 3.7             | 3.4 | 3.2 | 3.7             | 3.8 | 3.3 | 3.2             | 3.6 | 3.3 | 3.2             | 3.3 |     | 2.9             | 2.9 |     | 2.7             | 2.7 |     |
| 24.0  | 3.5             | 3.2 | 3.1 | 3.1             | 3.6 | 3.2 | 2.6             | 3.5 | 3.2 | 2.6             | 3.3 | 3.1 | 2.6             | 2.9 |     | 2.4             | 2.7 |     |
| 26.0  | 3.3             | 3.1 |     | 2.5             | 3.2 | 3.1 | 2.1             | 2.9 | 3.1 | 2.1             | 2.8 | 3.0 | 2.1             | 2.9 | 2.9 | 2.0             | 2.7 | 2.7 |
| 28.0  |                 |     |     | 2.0             | 2.6 | 3.0 | 1.6             | 2.3 | 2.9 | 1.6             | 2.3 | 2.9 | 1.7             | 2.3 | 2.8 | 1.5             | 2.2 | 2.6 |
| 30.0  |                 |     |     | 1.5             | 2.1 | 2.6 | 1.2             | 1.9 | 2.4 | 1.2             | 1.9 | 2.4 | 1.3             | 1.9 | 2.4 | 1.1             | 1.8 | 2.3 |
| 32.0  |                 |     |     | 1.2             | 1.7 | 2.1 | 0.9             | 1.5 | 1.9 |                 | 1.5 | 2.0 |                 | 1.5 | 2.0 |                 | 1.4 | 1.9 |
| 34.0  |                 |     |     | 0.8             | 1.3 | 1.6 |                 | 1.1 | 1.5 |                 | 1.1 | 1.5 |                 | 1.2 | 1.6 |                 | 1.1 | 1.5 |
| 36.0  |                 |     |     | 0.6             | 1.0 | 1.2 |                 |     | 1.2 |                 |     | 1.2 |                 | 1.3 |     |                 |     | 1.2 |
| 38.0  |                 |     |     |                 | 0.6 | 0.9 |                 |     | 0.8 |                 |     | 0.9 |                 | 0.9 |     |                 |     |     |
| 40.0  |                 |     |     |                 |     | 0.6 |                 |     |     |                 |     |     |                 |     |     |                 |     |     |







| m    | 11.1 m + 10.0 m |      |     | 33.2 m + 10.0 m |     |     | 40.5 m + 10.0 m |     |     | 44.2 m + 10.0 m |     |     | 47.9 m + 10.0 m |     |     | 51.2 m + 10.0 m |     |     |
|------|-----------------|------|-----|-----------------|-----|-----|-----------------|-----|-----|-----------------|-----|-----|-----------------|-----|-----|-----------------|-----|-----|
|      | 0°              | 20°  | 40° | 0°              | 20° | 40° | 0°              | 20° | 40° | 0°              | 20° | 40° | 0°              | 20° | 40° | 0°              | 20° | 40° |
| 3.0  | 12.2            |      |     |                 |     |     |                 |     |     |                 |     |     |                 |     |     |                 |     |     |
| 3.5  | 12.2            |      |     |                 |     |     |                 |     |     |                 |     |     |                 |     |     |                 |     |     |
| 4.0  | 12.2            |      |     |                 |     |     |                 |     |     |                 |     |     |                 |     |     |                 |     |     |
| 4.5  | 12.2            |      |     |                 |     |     |                 |     |     |                 |     |     |                 |     |     |                 |     |     |
| 5.0  | 12.2            | 12.2 |     |                 |     |     |                 |     |     |                 |     |     |                 |     |     |                 |     |     |
| 6.0  | 12.2            | 11.5 |     |                 |     |     |                 |     |     |                 |     |     |                 |     |     |                 |     |     |
| 7.0  | 12.2            | 10.8 |     | 10.1            |     |     |                 |     |     |                 |     |     |                 |     |     |                 |     |     |
| 8.0  | 12.2            | 10.2 | 8.8 | 10.1            |     |     |                 |     |     |                 |     |     |                 |     |     |                 |     |     |
| 9.0  | 12.1            | 9.7  | 8.4 | 10.1            |     |     | 7.7             |     |     |                 |     |     |                 |     |     |                 |     |     |
| 10.0 | 11.3            | 9.2  | 8.1 | 10.1            | 9.0 |     | 7.7             |     |     | 6.5             |     |     |                 |     |     |                 |     |     |
| 11.0 | 10.6            | 8.8  | 7.9 | 10.1            | 8.6 |     | 7.7             |     |     | 6.5             |     |     |                 |     |     |                 |     |     |
| 12.0 | 10.0            | 8.5  | 7.6 | 9.6             | 8.3 |     | 7.7             | 7.6 |     | 6.5             |     |     | 4.9             |     |     |                 |     |     |
| 14.0 | 8.9             | 7.9  | 7.3 | 7.5             | 7.6 | 6.7 | 6.8             | 7.0 |     | 6.5             | 6.5 |     | 4.9             |     |     | 4.4             |     |     |
| 16.0 | 8.1             | 7.4  |     | 5.9             | 6.7 | 6.3 | 5.4             | 6.2 | 5.8 | 5.3             | 6.1 | 5.5 | 4.9             | 4.9 |     | 4.4             | 4.4 |     |
| 18.0 |                 |      |     | 4.7             | 5.4 | 6.0 | 4.3             | 5.0 | 5.6 | 4.2             | 4.9 | 5.3 | 4.4             | 4.9 | 4.7 | 4.2             | 4.4 |     |
| 20.0 |                 |      |     | 3.8             | 4.4 | 4.9 | 3.4             | 4.0 | 4.5 | 3.4             | 4.0 | 4.5 | 3.5             | 4.1 | 4.5 | 3.4             | 3.9 | 4.2 |
| 22.0 |                 |      |     | 3.0             | 3.5 | 3.9 | 2.6             | 3.2 | 3.6 | 2.6             | 3.2 | 3.6 | 2.8             | 3.3 | 3.8 | 2.7             | 3.2 | 3.6 |
| 24.0 |                 |      |     | 2.3             | 2.7 | 3.1 | 2.0             | 2.5 | 2.9 | 2.0             | 2.5 | 2.9 | 2.2             | 2.7 | 3.1 | 2.1             | 2.6 | 2.9 |
| 26.0 |                 |      |     | 1.7             | 2.1 | 2.4 | 1.5             | 1.9 | 2.3 | 1.5             | 2.0 | 2.3 | 1.7             | 2.1 | 2.5 | 1.6             | 2.0 | 2.4 |
| 28.0 |                 |      |     | 1.2             | 1.6 | 1.8 | 1.1             | 1.4 | 1.7 | 1.1             | 1.5 | 1.8 | 1.3             | 1.7 | 2.0 | 1.2             | 1.5 | 1.9 |
| 30.0 |                 |      |     | 0.8             | 1.1 | 1.3 |                 | 1.0 | 1.2 |                 | 1.1 | 1.3 |                 | 1.2 | 1.5 |                 | 1.1 | 1.4 |
| 32.0 |                 |      |     | 0.5             | 0.7 | 0.9 |                 |     | 0.8 |                 |     | 0.9 |                 | 1.1 |     |                 |     | 1.0 |



| m    | 11.1 m + 18.0 m |     |     | 33.2 m + 18.0 m |     |     | 40.5 m + 18.0 m |     |     | 44.2 m + 18.0 m |     |     | 47.9 m + 18.0 m |     |     | 51.2 m + 18.0 m |     |     |
|------|-----------------|-----|-----|-----------------|-----|-----|-----------------|-----|-----|-----------------|-----|-----|-----------------|-----|-----|-----------------|-----|-----|
|      | 0°              | 20° | 40° | 0°              | 20° | 40° | 0°              | 20° | 40° | 0°              | 20° | 40° | 0°              | 20° | 40° | 0°              | 20° | 40° |
| 3.5  | 5.8             |     |     |                 |     |     |                 |     |     |                 |     |     |                 |     |     |                 |     |     |
| 4.0  | 5.8             |     |     |                 |     |     |                 |     |     |                 |     |     |                 |     |     |                 |     |     |
| 4.5  | 5.8             |     |     |                 |     |     |                 |     |     |                 |     |     |                 |     |     |                 |     |     |
| 5.0  | 5.8             |     |     |                 |     |     |                 |     |     |                 |     |     |                 |     |     |                 |     |     |
| 6.0  | 5.8             |     |     |                 |     |     |                 |     |     |                 |     |     |                 |     |     |                 |     |     |
| 7.0  | 5.8             |     |     |                 |     |     |                 |     |     |                 |     |     |                 |     |     |                 |     |     |
| 8.0  | 5.8             |     |     |                 |     |     |                 |     |     |                 |     |     |                 |     |     |                 |     |     |
| 9.0  | 5.8             |     |     | 4.2             |     |     |                 |     |     |                 |     |     |                 |     |     |                 |     |     |
| 10.0 | 5.8             | 5.3 |     | 4.2             |     |     |                 |     |     |                 |     |     |                 |     |     |                 |     |     |
| 11.0 | 5.8             | 5.0 |     | 4.2             |     |     |                 |     |     |                 |     |     |                 |     |     |                 |     |     |
| 12.0 | 5.7             | 4.8 |     | 4.2             |     |     |                 |     |     |                 |     |     |                 |     |     |                 |     |     |
| 14.0 | 5.1             | 4.4 |     | 4.2             |     |     | 3.6             |     |     | 3.3             |     |     |                 |     |     |                 |     |     |
| 16.0 | 4.7             | 4.1 | 3.7 | 4.2             | 4.2 |     | 3.6             |     |     | 3.3             |     |     | 2.9             |     |     | 2.7             |     |     |
| 18.0 | 4.3             | 3.8 | 3.5 | 4.2             | 4.1 |     | 3.6             | 3.6 |     | 3.3             |     |     | 2.9             |     |     | 2.7             |     |     |
| 20.0 | 4.0             | 3.5 | 3.3 | 4.2             | 3.9 | 3.4 | 3.6             | 3.6 |     | 3.3             | 3.3 |     | 2.9             | 2.9 |     | 2.7             |     |     |
| 22.0 | 3.7             | 3.4 | 3.2 | 3.4             | 3.8 | 3.3 | 3.0             | 3.6 | 3.3 | 2.9             | 3.3 |     | 2.9             | 2.9 |     | 2.7             | 2.7 |     |
| 24.0 | 3.5             | 3.2 | 3.1 | 2.8             | 3.6 | 3.2 | 2.4             | 3.2 | 3.2 | 2.3             | 3.2 | 3.1 | 2.4             | 2.9 |     | 2.2             | 2.7 |     |
| 26.0 | 3.3             | 3.1 |     | 2.3             | 3.0 | 3.1 | 1.9             | 2.6 | 3.1 | 1.8             | 2.6 | 3.0 | 1.9             | 2.6 | 2.9 | 1.7             | 2.5 | 2.7 |
| 28.0 |                 |     |     | 1.8             | 2.4 | 3.0 | 1.4             | 2.1 | 2.7 | 1.4             | 2.1 | 2.7 | 1.5             | 2.1 | 2.7 | 1.3             | 2.0 | 2.6 |
| 30.0 |                 |     |     | 1.4             | 1.9 | 2.4 | 1.1             | 1.7 | 2.2 | 1.0             | 1.7 | 2.2 | 1.1             | 1.7 | 2.3 |                 | 1.6 | 2.2 |
| 32.0 |                 |     |     | 1.0             | 1.5 | 1.9 |                 | 1.3 | 1.8 |                 | 1.3 | 1.8 |                 | 1.3 | 1.8 |                 | 1.2 | 1.7 |
| 34.0 |                 |     |     | 0.7             | 1.1 | 1.5 |                 | 0.9 | 1.4 |                 | 0.9 | 1.4 |                 | 1.0 | 1.4 |                 |     | 1.4 |
| 36.0 |                 |     |     |                 | 0.8 | 1.1 |                 |     | 1.0 |                 |     | 1.0 |                 |     | 1.1 |                 |     |     |
| 38.0 |                 |     |     |                 | 0.5 | 0.8 |                 |     |     |                 |     |     |                 |     |     |                 |     |     |

Tragfähigkeiten  
Lifting capacities  
Capacités de levage  
Capacidades de elevación

|  <span style="float: right; border: 1px solid black; padding: 2px;">DIN/ISO/EN</span> |                 |      |     |                 |     |     |                 |     |     |                 |     |     |                 |     |     |                 |     |     |
|---|-----------------|------|-----|-----------------|-----|-----|-----------------|-----|-----|-----------------|-----|-----|-----------------|-----|-----|-----------------|-----|-----|
| <br>m   | 11.1 m + 10.0 m |      |     | 33.2 m + 10.0 m |     |     | 40.5 m + 10.0 m |     |     | 44.2 m + 10.0 m |     |     | 47.9 m + 10.0 m |     |     | 51.2 m + 10.0 m |     |     |
|   | 0°              | 20°  | 40° | 0°              | 20° | 40° | 0°              | 20° | 40° | 0°              | 20° | 40° | 0°              | 20° | 40° | 0°              | 20° | 40° |
| 3.0   | 12.2            |      |     |                 |     |     |                 |     |     |                 |     |     |                 |     |     |                 |     |     |
| 3.5   | 12.2            |      |     |                 |     |     |                 |     |     |                 |     |     |                 |     |     |                 |     |     |
| 4.0   | 12.2            |      |     |                 |     |     |                 |     |     |                 |     |     |                 |     |     |                 |     |     |
| 4.5   | 12.2            |      |     |                 |     |     |                 |     |     |                 |     |     |                 |     |     |                 |     |     |
| 5.0   | 12.2            | 12.2 |     |                 |     |     |                 |     |     |                 |     |     |                 |     |     |                 |     |     |
| 6.0   | 12.2            | 11.5 |     |                 |     |     |                 |     |     |                 |     |     |                 |     |     |                 |     |     |
| 7.0   | 12.2            | 10.8 |     | 10.1            |     |     |                 |     |     |                 |     |     |                 |     |     |                 |     |     |
| 8.0   | 12.2            | 10.2 | 8.8 | 10.1            |     |     |                 |     |     |                 |     |     |                 |     |     |                 |     |     |
| 9.0   | 12.1            | 9.7  | 8.4 | 10.1            |     |     | 7.7             |     |     |                 |     |     |                 |     |     |                 |     |     |
| 10.0  | 11.3            | 9.2  | 8.1 | 9.1             | 9.0 |     | 7.7             |     |     | 6.5             |     |     |                 |     |     |                 |     |     |
| 11.0  | 10.6            | 8.8  | 7.9 | 7.8             | 8.6 |     | 7.0             |     |     | 6.5             |     |     |                 |     |     |                 |     |     |
| 12.0  | 10.0            | 8.5  | 7.6 | 6.7             | 7.8 |     | 6.0             | 7.1 |     | 5.9             |     |     | 4.9             |     |     |                 |     |     |
| 14.0  | 7.7             | 7.9  | 7.3 | 5.0             | 6.0 | 6.7 | 4.5             | 5.4 |     | 4.4             | 5.3 |     | 4.6             |     |     | 4.3             |     |     |
| 16.0  | 6.0             | 6.4  |     | 3.8             | 4.6 | 5.3 | 3.3             | 4.1 | 4.8 | 3.3             | 4.1 | 4.8 | 3.5             | 4.2 | 3.8 | 3.3             | 4.0 |     |
| 18.0  |                 |      |     | 2.9             | 3.5 | 4.1 | 2.4             | 3.1 | 3.7 | 2.4             | 3.1 | 3.7 | 2.6             | 3.3 | 3.8 | 2.4             | 3.1 |     |
| 20.0  |                 |      |     | 2.1             | 2.7 | 3.2 | 1.7             | 2.3 | 2.8 | 1.7             | 2.3 | 2.8 | 1.9             | 2.5 | 3.0 | 1.8             | 2.4 | 2.9 |
| 22.0  |                 |      |     | 1.5             | 2.0 | 2.4 |                 | 1.7 | 2.1 |                 | 1.7 | 2.1 | 1.3             | 1.9 | 2.3 |                 | 1.7 | 2.2 |
| 24.0  |                 |      |     | 1.0             | 1.4 | 1.7 |                 |     | 1.5 |                 |     | 1.5 |                 | 1.3 | 1.7 |                 |     | 1.6 |
| 26.0  |                 |      |     |                 | 0.9 | 1.2 |                 |     |     |                 |     |     |                 | 1.2 |     |                 |     |     |

|  <span style="float: right; border: 1px solid black; padding: 2px;">DIN/ISO/EN</span> |                 |     |     |                 |     |     |                 |     |     |                 |     |     |                 |     |     |                 |     |     |
|---|-----------------|-----|-----|-----------------|-----|-----|-----------------|-----|-----|-----------------|-----|-----|-----------------|-----|-----|-----------------|-----|-----|
| <br>m   | 11.1 m + 18.0 m |     |     | 33.2 m + 18.0 m |     |     | 40.5 m + 18.0 m |     |     | 44.2 m + 18.0 m |     |     | 47.9 m + 18.0 m |     |     | 51.2 m + 18.0 m |     |     |
|   | 0°              | 20° | 40° | 0°              | 20° | 40° | 0°              | 20° | 40° | 0°              | 20° | 40° | 0°              | 20° | 40° | 0°              | 20° | 40° |
| 3.5   | 5.8             |     |     |                 |     |     |                 |     |     |                 |     |     |                 |     |     |                 |     |     |
| 4.0   | 5.8             |     |     |                 |     |     |                 |     |     |                 |     |     |                 |     |     |                 |     |     |
| 4.5   | 5.8             |     |     |                 |     |     |                 |     |     |                 |     |     |                 |     |     |                 |     |     |
| 5.0   | 5.8             |     |     |                 |     |     |                 |     |     |                 |     |     |                 |     |     |                 |     |     |
| 6.0   | 5.8             |     |     |                 |     |     |                 |     |     |                 |     |     |                 |     |     |                 |     |     |
| 7.0   | 5.8             |     |     |                 |     |     |                 |     |     |                 |     |     |                 |     |     |                 |     |     |
| 8.0   | 5.8             |     |     |                 |     |     |                 |     |     |                 |     |     |                 |     |     |                 |     |     |
| 9.0   | 5.8             |     |     | 4.2             |     |     |                 |     |     |                 |     |     |                 |     |     |                 |     |     |
| 10.0  | 5.8             | 5.3 |     | 4.2             |     |     |                 |     |     |                 |     |     |                 |     |     |                 |     |     |
| 11.0  | 5.8             | 5.0 |     | 4.2             |     |     |                 |     |     |                 |     |     |                 |     |     |                 |     |     |
| 12.0  | 5.7             | 4.8 |     | 4.2             |     |     |                 |     |     |                 |     |     |                 |     |     |                 |     |     |
| 14.0  | 5.1             | 4.4 |     | 4.2             |     |     | 3.6             |     |     | 3.3             |     |     |                 |     |     |                 |     |     |
| 16.0  | 4.7             | 4.1 | 3.7 | 4.2             | 4.2 |     | 3.6             |     |     | 3.3             |     |     | 2.9             |     |     | 2.7             |     |     |
| 18.0  | 4.3             | 3.8 | 3.5 | 3.3             | 4.1 |     | 2.8             | 3.6 |     | 2.7             |     |     | 2.7             |     |     | 2.6             |     |     |
| 20.0  | 4.0             | 3.5 | 3.3 | 2.5             | 3.6 | 3.4 | 2.1             | 3.1 |     | 2.0             | 3.1 |     | 2.1             | 2.9 |     | 1.9             |     |     |
| 22.0  | 3.7             | 3.4 | 3.2 | 1.9             | 2.8 | 3.3 | 1.5             | 2.5 | 3.3 | 1.5             | 2.4 |     | 1.5             | 2.4 |     |                 | 2.3 |     |
| 24.0  | 3.3             | 3.2 | 3.1 | 1.4             | 2.2 | 2.9 |                 | 1.9 | 2.6 |                 | 1.9 | 2.6 |                 | 1.9 |     |                 | 1.8 |     |
| 26.0  | 2.8             | 2.9 |     | 1.0             | 1.7 | 2.3 |                 | 1.4 | 2.1 |                 | 1.4 | 2.0 |                 | 1.4 | 2.1 |                 |     | 2.0 |
| 28.0  |                 |     |     |                 | 1.3 | 1.8 |                 |     | 1.6 |                 |     | 1.6 |                 |     | 1.6 |                 |     | 1.5 |
| 30.0  |                 |     |     |                 | 0.9 | 1.4 |                 |     | 1.1 |                 |     |     |                 |     |     |                 |     |     |
| 32.0  |                 |     |     |                 |     | 0.9 |                 |     |     |                 |     |     |                 |     |     |                 |     |     |





Hubhöhen  
Lifting heights  
Hauteurs de levage  
Alturas de elevación

Tragfähigkeiten  
Lifting capacities  
Capacités de levage  
Capacidades de elevación

**22.5t** **DIN/ISO/EN**

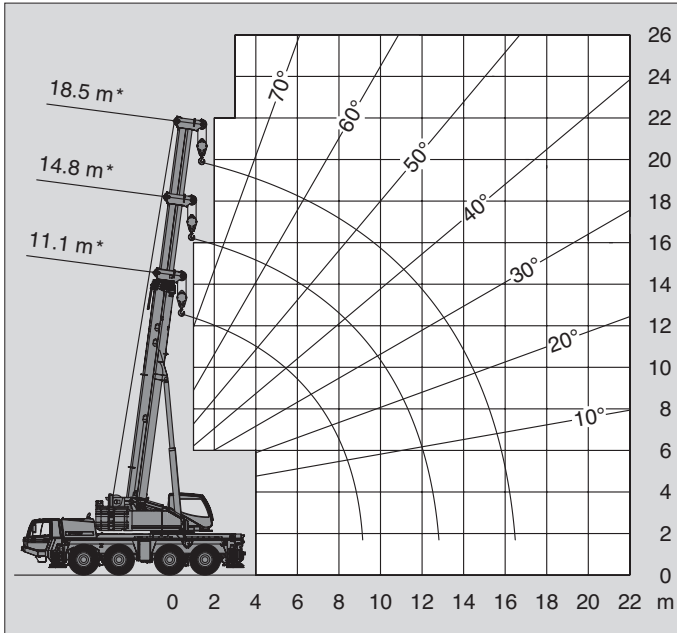

**22.5t** **DIN/ISO/EN**

| → m  | 11.1 m* | 14.8 m* | 18.5 m* |
|------|---------|---------|---------|
| 3.0  | 17.1    | 17.4    | 17.7    |
| 3.5  | 15.6    | 16.0    | 16.2    |
| 4.0  | 14.3    | 14.7    | 14.9    |
| 4.5  | 13.2    | 13.6    | 13.8    |
| 5.0  | 12.2    | 12.6    | 12.8    |
| 6.0  | 10.5    | 10.9    | 11.2    |
| 7.0  | 9.1     | 9.6     | 9.8     |
| 8.0  | 8.0     | 8.5     | 8.7     |
| 9.0  | 7.1     | 7.5     | 7.8     |
| 10.0 |         | 6.7     | 7.0     |
| 11.0 |         | 6.1     | 6.3     |
| 12.0 |         | 5.5     | 5.8     |
| 14.0 |         |         | 4.8     |
| 16.0 |         |         | 3.9     |

\* Oberwagenverriegelung eingelegt \* Superstructure verrouillé  
\* Superstructure locked \* Bloqueo de superestructura

**16.3t** **DIN/ISO/EN**

| → m  | 11.1 m* | 14.8 m* | 18.5 m* |
|------|---------|---------|---------|
| 3.0  | 17.3    | 17.7    | 18.0    |
| 3.5  | 15.8    | 16.2    | 16.5    |
| 4.0  | 14.5    | 14.9    | 15.2    |
| 4.5  | 13.4    | 13.8    | 14.1    |
| 5.0  | 12.4    | 12.8    | 13.1    |
| 6.0  | 10.7    | 11.1    | 11.4    |
| 7.0  | 9.3     | 9.8     | 10.0    |
| 8.0  | 8.2     | 8.6     | 8.9     |
| 9.0  | 6.8     | 7.6     | 8.0     |
| 10.0 |         | 6.4     | 6.9     |
| 11.0 |         | 5.5     | 5.9     |
| 12.0 |         | 4.7     | 5.1     |
| 14.0 |         |         | 3.9     |
| 16.0 |         |         | 3.0     |

\* Oberwagenverriegelung eingelegt \* Superstructure verrouillé  
\* Superstructure locked \* Bloqueo de superestructura

**10.2t** **DIN/ISO/EN**

| → m  | 11.1 m* | 14.8 m* | 18.5 m* |
|------|---------|---------|---------|
| 3.0  | 17.6    | 18.0    | 18.3    |
| 3.5  | 16.1    | 16.5    | 16.7    |
| 4.0  | 14.8    | 15.2    | 15.4    |
| 4.5  | 13.6    | 14.0    | 14.3    |
| 5.0  | 12.6    | 13.0    | 13.3    |
| 6.0  | 10.3    | 11.1    | 11.6    |
| 7.0  | 8.0     | 8.8     | 9.3     |
| 8.0  | 6.4     | 7.2     | 7.6     |
| 9.0  | 5.1     | 5.9     | 6.4     |
| 10.0 |         | 4.9     | 5.4     |
| 11.0 |         | 4.1     | 4.5     |
| 12.0 |         | 3.5     | 3.9     |
| 14.0 |         |         | 2.9     |
| 16.0 |         |         | 2.0     |

\* Oberwagenverriegelung eingelegt \* Superstructure verrouillé  
\* Superstructure locked \* Bloqueo de superestructura

**6.0t** **DIN/ISO/EN**

| → m  | 11.1 m* | 14.8 m* | 18.5 m* |
|------|---------|---------|---------|
| 3.0  | 17.8    | 18.2    | 18.5    |
| 3.5  | 16.3    | 16.7    | 16.9    |
| 4.0  | 15.0    | 15.4    | 15.6    |
| 4.5  | 13.2    | 14.1    | 14.5    |
| 5.0  | 11.3    | 12.2    | 12.7    |
| 6.0  | 8.4     | 9.3     | 9.8     |
| 7.0  | 6.5     | 7.3     | 7.8     |
| 8.0  | 5.1     | 5.8     | 6.3     |
| 9.0  | 4.0     | 4.7     | 5.2     |
| 10.0 |         | 3.9     | 4.3     |
| 11.0 |         | 3.2     | 3.6     |
| 12.0 |         | 2.6     | 3.0     |
| 14.0 |         |         | 2.1     |
| 16.0 |         |         | 1.4     |

\* Oberwagenverriegelung eingelegt \* Superstructure verrouillé  
\* Superstructure locked \* Bloqueo de superestructura

**5.1t** **DIN/ISO/EN**

| → m  | 11.1 m* | 14.8 m* | 18.5 m* |
|------|---------|---------|---------|
| 3.0  | 17.9    | 18.3    | 18.5    |
| 3.5  | 16.4    | 16.7    | 17.0    |
| 4.0  | 14.9    | 15.4    | 15.7    |
| 4.5  | 12.4    | 13.3    | 13.9    |
| 5.0  | 10.6    | 11.5    | 12.0    |
| 6.0  | 7.9     | 8.7     | 9.2     |
| 7.0  | 6.0     | 6.8     | 7.3     |
| 8.0  | 4.7     | 5.4     | 5.9     |
| 9.0  | 3.6     | 4.4     | 4.8     |
| 10.0 |         | 3.5     | 4.0     |
| 11.0 |         | 2.9     | 3.3     |
| 12.0 |         | 2.3     | 2.8     |
| 14.0 |         |         | 1.9     |
| 16.0 |         |         | 1.2     |

\* Oberwagenverriegelung eingelegt \* Superstructure verrouillé  
\* Superstructure locked \* Bloqueo de superestructura

Anmerkungen zu den Traglasttabellen  
Remarks relating to the rating charts  
Remarques relatives aux tableaux des charges  
Notas relativas a los graficos de carga

**DIN/ISO/EN****Anmerkungen zu den Traglasttabellen**

Die Tragfähigkeiten im Festigkeitsbereich basieren auf DIN 15018 Blatt 2 und Blatt 3 und F.E.M.

Die Tragfähigkeiten im Standsicherheitsbereich entsprechen DIN 15019 Teil 2 / ISO 4305 / EN 13000.

In Abhängigkeit der Auslegerlänge sind bei den Traglasttabellen Windgeschwindigkeiten bis max. 15 m/s zulässig.

Die Tragfähigkeiten sind in metrischen Tonnen angegeben.

Das Gewicht des Lashakens bzw. der Hakenflasche und weiterer Anschlagmittel ist von der Tragfähigkeit abzuziehen.

Die Tragfähigkeiten für den Teleskopausleger gelten nur bei demon- tierter Auslegerverlängerung.

Die Ausladung ist der horizontale Abstand von Mitte Drehkranz bis Mitte freihängender, nicht schwingender Last.

Tragfähigkeitsänderungen vorbehalten.

Obige Angaben dienen nur zur Information. Die Bedienungsanlei- tungen müssen zu Rate gezogen werden, bevor die Maschine in Betrieb genommen wird. Alle hier gemachten Angaben beziehen sich auf die Standard-Ausführung. Jegliche Ausrüstungsverände- rungen können die angegebenen Werte beeinflussen.

**Remarks relating to the rating charts**

The lifting capacities in the structural area are based on DIN 15018 parts 2 and 3 and F.E.M.

The lifting capacities in the stability area are based on DIN 15019 part 2 / ISO 4305 / EN 13000.

Depending on the boom length, with the lifting capacity charts, wind speeds up to max. 15 m/s are admissible.

The lifting capacities are shown in metric tons.

The weight of load handling devices such as hook blocks, slings, etc., must be considered as part of the load and must be deducted from the lifting capacities.

The lifting capacities for the telescopic boom apply to a crane with no boom extensions being stowed or mounted on the crane.

The working radius is the horizontal distance from the centre of rotation to the centre of the freely suspended non-oscillating load.

The lifting capacities are subject to change without prior notice.

The above remarks are for basic information only and the operator's manual must be consulted before operating this crane. All data and performances refer to the standard crane. The addition of optional and other equipment may affect the performance of the crane.

**Remarques relatives aux tableaux des charges**

Les forces de levage sont conformes aux normes DIN 15018, p. 2 et 3, et F.E.M.

Les forces de levage dans la partie de stabilité au renversement sont conformes aux normes DIN 15019, chap. 2 / ISO 4305 / EN 13000.

En fonction de la longueur de la flèche, des vitesses du vent jusqu'à 15 m/s maxi. sont admissibles avec les tableaux des charges.

Les forces de levage sont données en tonnes métriques.

Le poids du crochet-moufle et de tous les accessoires d'élingage font partie de la charge et sont à déduire des charges indiquées.

Les forces de levage indiquées pour la flèche télescopique s'entendent fléchette déposée.

Comme portée, on entend la distance horizontale du centre de la couronne de rotation au centre de la charge librement suspendue et non oscillante.

Sauf modification de forces de levage.

Les données ci-dessus servent à titre d'information. Avant la mise en marche de la grue il est conseillé d'étudier les instructions de service. Toutes les données indiquées ci-dessus se réfèrent à la machine de base. Tout changement de l'équipement de la grue peut influencer ces valeurs.

**Notas relativas a los graficos de carga**

En cuanto a los datos referentes a resistencia, las capacidades de carga están basados sobre las normas DIN 15018, pág. 2 y 3, y F.E.M.

En cuanto a los datos referentes a estabilidad anti-vuelco, las capacidades de carga están basados sobre las normas DIN 15019, Cap. 2 / ISO 4305 / EN 13000.

En función de la longitud de la pluma, las tablas de carga permiten velocidades del viento hasta un máximo de 15 m/s.

Las capacidades de carga indicadas en las tablas corresponden a toneladas métricas.

Hay que deducir los pesos del gancho, eslingas y de otros dispositivos para fijación de cargas de los valores indicados en las tablas.

Las capacidades de carga referentes a la pluma telescópica valen solamente si el plumín está desmontada.

Como alcance se entiende la distancia horizontal desde el centro de la corona de giro hasta el centro de la carga suspendida libremente y no oscilante.

Salvo modificación de capacidades de carga, sin previo aviso.

Los datos arriba indicados sirven solamente para su información. Hay que leer las instrucciones para el uso antes de la puesta en servicio de la máquina. Todos los datos mencionados en las presentes tablas rigen para los modelos standard. Cualquier modificación del equipo montado puede dar lugar a modificaciones de aquellos valores.

Gegengewichtvarianten  
 Counterweight versions  
 Variations des contrepoids  
 Variaciones de contrapeso

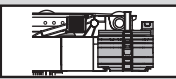
|  | Gegengewicht / Counterweight<br>Contrepoids / Contrapeso | 1 x | 1 x | 1 x | 1 x | 2 x | 1 x | 3 x | 1 x |
|---|--|-----|-----|-----|-----|-----|-----|-----|-----|
|   | (t)  | ①   | ②   | ③   | ④   | ⑤   | ⑥   | ⑦   | ⑧   |
|   |  | 1.0 | 0.7 | 0.7 | 1.1 | 1.6 | 6.2 | 2.9 | 0.9 |

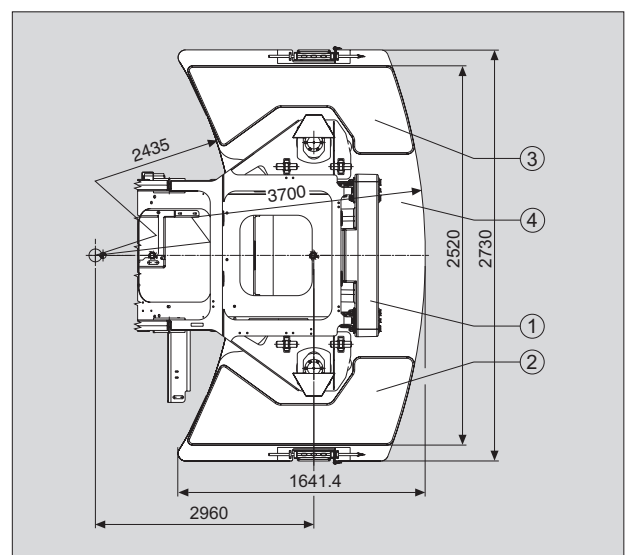
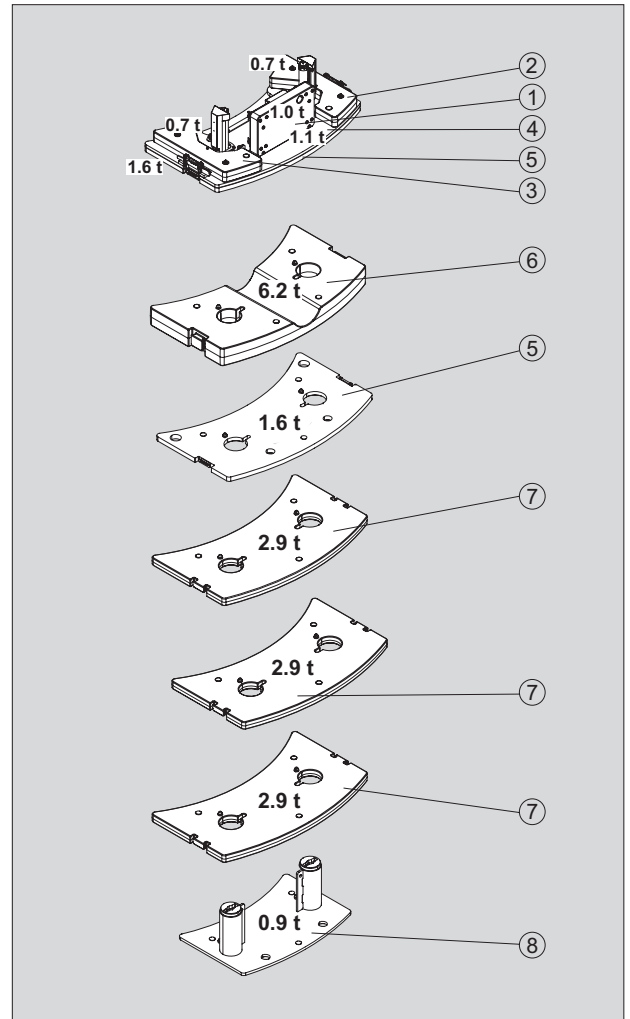
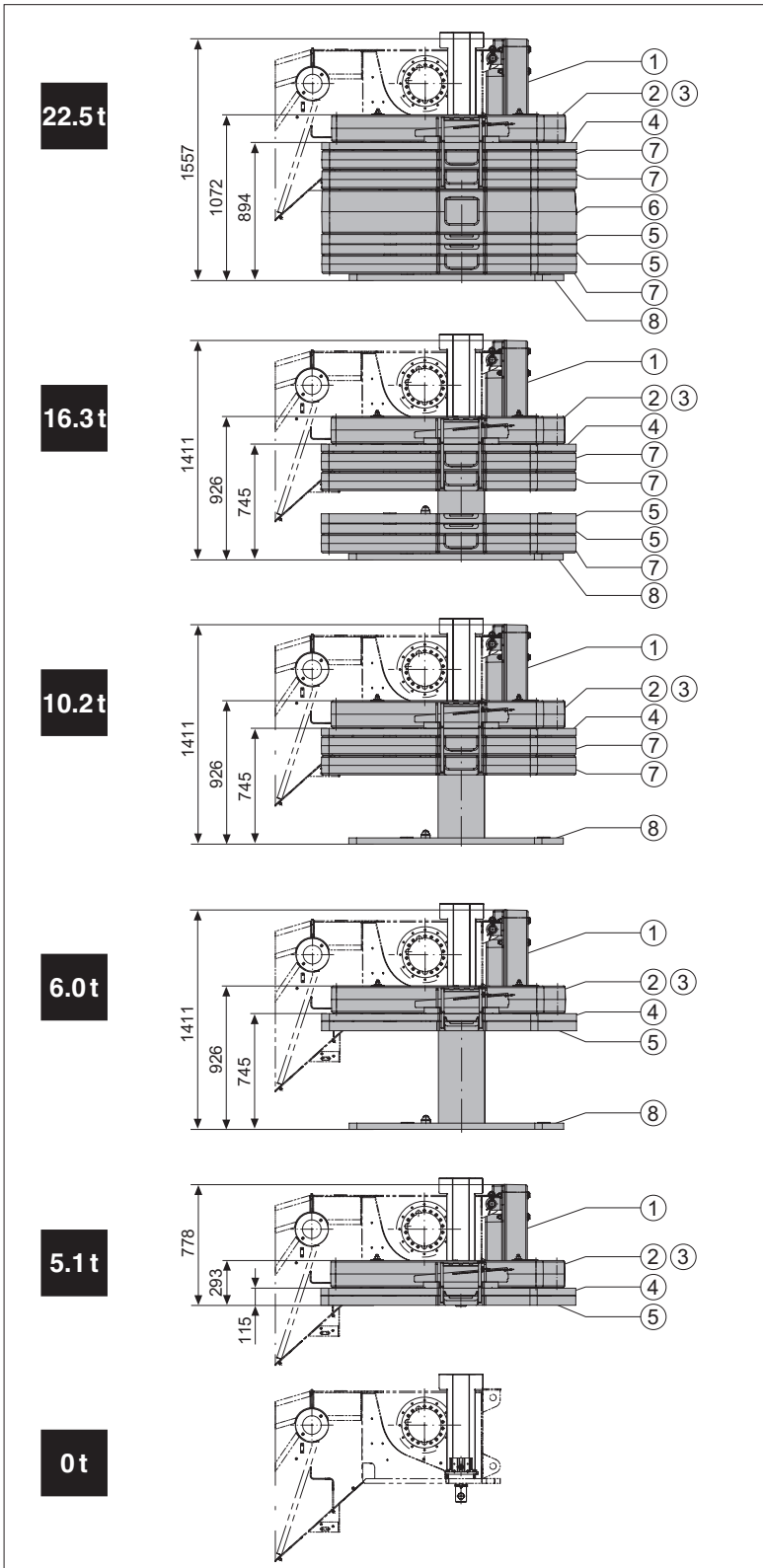

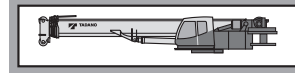
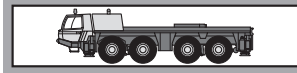

**Rahmen** Verwindungs- und biegesteife Schweißkonstruktion aus hochfestem Feinkornstahl. Zentralschmieranlage.

**Abstützung** 4-Punkt-Abstützung, hydraulisch, Bedienungsmöglichkeiten an beiden Seiten des Fahrgestelles und in der Oberwagenkabine.  
Abstützbasis 7,2 m (und 5,0 m) x 8,5 m.

**Motor** Mercedes-Benz 6-Zylinder-Dieselmotor OM 470 LA (Euromot IV / EPA Tier 4f), wassergekühlt, Leistung 320 kW (435 PS) bei 1700 min<sup>-1</sup>. Drehmoment 2100 Nm bei 1300 min<sup>-1</sup>. Motorleistung nach ECE R 120.  
Kraftstoffbehälter 400 l. AdBlue-Behälter 40 l.

**Getriebe** ZF-AS-Tronic 12 AS 2531, mechanisches Schaltgetriebe mit integriertem Intarder, elektronisch-pneumatisch betätigter Trockenkupplung und vollautomatischer Schaltung mit 12 Vorwärts- und 2 Rückwärtsgängen.

**Verteilergetriebe** 2-stufiges Verteilergetriebe.

**Antrieb** 8 x 6 (8 x 8 Option).

### Achsen

1. Achse: gelenkt, nicht angetrieben.
2. Achse: gelenkt, angetrieben, Differentialsperre quer.
3. Achse: gelenkt, angetrieben, Differentialsperre längs und quer.
4. Achse: gelenkt, angetrieben, Differentialsperre quer.

**Achsaufhängung** Hydropneumatische Federung mit Niveauregulierung.

**Bremsen** Druckluft-Zweikreis-Scheibenbremsanlage mit ABS System. Feststellbremse als Federspeicherbremse an der 2., 3. und 4. Achse wirkend. Intarder und Motorbremse als Dauerbremse.

**Räder** 8-fach 445/95 R 25 (16.00 R 25), Breite 2,75 m.

**Lenkung** ZF-Servocom-Zweikreishydraulenlenkung. Mechanische Lenkung der 1. und 2. Achse und Mitlenken der 4. Achse bis zu einer Geschwindigkeit von 25 km/h, hydraulisch unterstützt, mit Notlenkpumpe. Lenkung aller Achsen möglich. Hydrostatische Lenkung aller Achsen aus der Oberwagenkabine.

**Unterwagenkabine** Zwei-Mann-Frontfahrerhaus in Stahl-Kunststoff-Verbund-Konstruktion, Sicherheitsverglasung, luftgefederte Sitze (Fahrersitz mit Heizung) und motorabhängige Wasserheizung, Radio / CD-Player, Kontroll- und Bedienungselemente für den Fahrbetrieb, Tempomat- / Bremsomat-Funktion.

**Elektrische Anlage** 24 Volt-Gleichstrom, 2 Batterien, Abstützfeldbeleuchtung.  
Die elektrische Anlage entspricht der EG-Norm.

**Zusatzausrüstung** (gegen Mehrpreis)  
Anhängerkupplung, motorunabhängige Zusatzheizung mit Motorvorwärmung, Klimaanlage, 8 x 8 Antrieb, 525/80 R 25 (20.5 R 25) Bereifung, Reserverad, Sonderlackierung und Beschriftung.  
Weitere Zusatzausrüstung auf Anfrage.

**Rahmen** Verwindungssteife Schweißkonstruktion mit einer außenverzahnten, einreihigen Kugeldrehverbindung, um 360° unbegrenzt drehbar. Zentralschmieranlage.

**Motor** Mercedes-Benz 4-Zylinder-Dieselmotor OM 934 LA (Euromot IV / EPA Tier 4f), wassergekühlt. Drehzahl ist über Fußpedal stufenlos regelbar, Leistung 129 kW (175 PS) bei 2200 min<sup>-1</sup>. Drehmoment 750 Nm bei 1200 - 1600 min<sup>-1</sup>. Motorleistung nach ECE R 120.  
Kraftstoffbehälter 220 l. AdBlue-Behälter 10 l.

**Hydraulik System** Diesel-hydraulisch mit 3-Kreishydraulik, 1 leistungsgeregelte Axialkolbendoppelpumpe (elektrisch verstellbar), 1 Axialkolbenpumpe und 2 Zahnradpumpen, Ölkühler.

**Steuerung** Zwei 4-fach Kreuzsteuerhebel mit elektrischer Vorsteuerung.

**Teleskopausleger** Sechsteiliger Teleskopausleger aus hochfestem Feinkornstahl, bestehend aus einem Grundausleger und 5 Teleskopteilen, 1 Teleskopzylinder, hydraulisch unter Teillast teleskopierbar. 11,1m - 51,2 m lang. Rollenkopf mit 7 Seilrollen.

**Wippwerk** Ein Differentialzylinder mit angebautem Senkbremssperrventil.

**Hubwerk** Axialkolben-Motor, Hubwerkstrommel mit eingebautem Planetengetriebe und federbelasteter Hydro-Lamellenbremse mit integriertem Freilauf beim Heben. Hubseil mit 'Super-Stop' Einrichtung.

**Drehwerk** Axialkolben-Motor, zweistufiges Planetengetriebe mit fußbetätigter Betriebsbremse und Feststellung. Drehgeschwindigkeit stufenlos von 0 - 2 min<sup>-1</sup>.

**Gegengewicht** Standard 6,0 t teilbar.  
Die Bedienung erfolgt aus der Oberwagenkabine.

**Oberwagenkabine** Großräumige Krankabine in Stahl-Kunststoffausführung mit Sicherheitsverglasung und getönten Scheiben, kippbarem Arbeitsplatz mit verstellbarem, hydraulisch gedämpftem Fahrersitz mit Heizung, motorunabhängige Wasserheizung mit Motorvorwärmung, Klimaanlage, Radio / CD-Player, Kontroll- und Bedienungselemente für Kranbetrieb, Verfahrbarkeit vom Oberwagen und Abstützbetätigung.

**Elektrische Anlage** 24 Volt-Gleichstrom, 2 Batterien.

**Sicherheitseinrichtungen** Lastmomentbegrenzung (LMB), Arbeitsbereichsbegrenzung, Hubendschalter, Windenendschalter, Seilwindendrehmelder, Windmesser, Sicherheitsventile gegen Rohr- und Schlauchbrüche. Sperrventile an Hydraulik-Zylindern.

**Zusatzausrüstung** (gegen Mehrpreis)  
'Lift Adjuster', Auslegerverlängerung 10,0 m/ 18,0 m, wahlweise abwinkelbar 0°, 20° und 40° oder hydraulisch 0°- 40°, Schwerlastspitze 1,6 m, Zusatzgegengewicht 16,5 t, Gegengewichtsvarianten 0 t / 5,1 t / 6,0 t / 7,6 t / 10,2 t / 16,3 t / 22,5 t, verschiedene Unterflaschen, 2. Hubwerk, Drehbereichsbegrenzung, Zusatzölkühler, Sonderlackierung und Beschriftung.  
Weitere Zusatzausrüstung auf Anfrage.

## Equipment

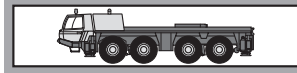

**Frame** Torsion-resistant, welded construction made from high strength, fine-grained steel. Central lubricating system.

**Outriggers** 4 point, double telescopic hydraulic outriggers with controls on both sides of carrier and in superstructure cab. Outrigger base 7.2 m (5.0 m mid extension) x 8.5 m.

**Carrier engine** Mercedes-Benz 6 cylinder model OM 470 LA (Euromot IV / EPA Tier 4f), water-cooled diesel engine. Rated at 320 kW (435 HP) at 1700 min<sup>-1</sup>. Torque 2100 Nm at 1300 min<sup>-1</sup>. Engine rating according to ECE R 120. Fuel tank 400 l. AdBlue-tank 40 l.

**Transmission** ZF-AS-Tronic 12 AS 2531 mechanical transmission with integrated Intarder, electro-pneumatically operated dry-type clutch and automatic gear shifting with 12 forward gears and 2 reverse gears.

**Transfer Case** Two stage.

**Drive** 8 x 6 (8 x 8 option)

### Axles

1<sup>st</sup> axle: steered, not driven.

2<sup>nd</sup> axle: steered, driven, with transverse differential lock.

3<sup>rd</sup> axle: steered, driven, with transverse and longitudinal differential lock.

4<sup>th</sup> axle: steered, driven, with transverse differential lock.

**Suspension** Hydro-pneumatic with levelling adjustment.

**Brake system** Service disk brakes: dual circuit compressed airsystem. Parking brake: spring loaded type acting on 2<sup>nd</sup>, 3<sup>rd</sup> and 4<sup>th</sup> axles. Auxiliary brakes: Intarder and engine brake.

**Tyres** (8) 445/95 R 25 (16.00 R 25), width 2.75 m.

**Steering system** ZF-Servoacom, dual circuit hydraulic steering with emergency steering pump, mechanical hydraulically-assisted steering of front two axles and automatic steering of the 4<sup>th</sup> axle up to a travel speed of 25 km/h. Steering of all axles possible. All axles steered hydrostatically from superstructure cab.

**Carrier cab** Two man full width cab of composite (steel sheet metal and fibre-glass) structure, with safety glass, air-cushioned adjustable seats (driver seat with heater) and engine dependent water heater, radio/CD-player, complete controls and instrumentation for road travel. Cruise control with hill braking feature functions.

**Electrical system** 24 volt DC system, 2 batteries, outrigger area lighting. Electrical system conforms with EEC regulations.

### Optional Equipment (at extra charge)

Towing attachment, engine independent additional heater with engine pre-heat, air conditioning, 8 x 8 drive, 525/80 R 25 (20.5 R 25) tyres, spare wheel and tyre, special painting and lettering.

Further optional equipment available upon request.

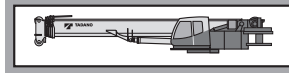

**Frame** Torsion-resistant, all-welded structure of high strength steel. Connected to carrier by single-row, ball-bearing slewing ring with external gearing for 360° continuous rotation. Central lubricating system.

**Superstructure engine** Mercedes-Benz 4 cylinder model OM 934 LA (Euromot IV / EPA Tier 4f), water cooled diesel engine. RPM infinitely variable via foot pedal, rating 129 kW (175 HP) at 2200 min<sup>-1</sup>. Torque 750 Nm at 1200 - 1600 min<sup>-1</sup>. Engine rating according to ECE R 120. Fuel tank 220 l. AdBlue-tank 10 l.

**Hydraulic system** Three circuit diesel hydraulic system with 1 power controlled double axial piston pump (electrically adjustable), 1 axial piston pump and 2 gear pumps, oil cooler.

**Controls** Electrical, 2 joy-stick levers for simultaneous operation of crane motions.

**Telescopic boom** 6 sections, made of high tensile, finegrained steel, consisting of 1 base section and 5 telescoping sections extended by means of a single telescopic cylinder. All telescope sections extendable under partial load. 11.1 m to 51.2 m long. Boom head with 7 sheaves.

**Derricking system** 1 double acting hydraulic cylinder with integral brake and holding valve.

**Main winch** Axial piston motor, winch drum with integrated planetary reduction and hydraulically controlled spring-loaded multiple disc brake and integrated free rotation (no sagging of load when hoisting). Hoist cable with 'Super-Stop' easy reeving system.

**Slewing system** Axial piston motor with two-stage planetary gear equipped with a foot actuated service and a parking brake. Speed infinitely variable 0 - 2 min<sup>-1</sup>.

**Counterweight** Standard 6.0 t divisible, assembled and disassembled by hydraulic cylinders controlled from superstructure cab.

**Superstructure cab** Spacious panoramic cab of composite structure with safety (tinted) glass windows, tiltable cockpit with hydraulically cushioned adjustable seat with heater, engine independent water heater with engine pre-heat, air conditioning, radio / CD-player, complete controls and instrumentation for crane operation, on-site travelling and outriggers.

**Electrical system** 24 volt DC system, 2 batteries.

**Safety devices** Load moment device (LMD), working area limiter, hoist limit switch, lower limit switch and drum turn indicator, anemometer, safety valves against pipe and hose rupture, holding valves on hydraulic cylinders.

### Optional Equipment (at extra charge)

'Lift Adjuster', Boom extension 10.0 m / 18.0 m, offsets 0°, 20° and 40° or hydraulically 0°- 40°, heavy duty jib 1.6 m, additional counterweight 16.5 t, counterweight variations 0 t / 5.1 t / 6.0 t / 7.6 t / 10.2 t / 16.3 t / 22.5 t, selection of hook blocks, auxiliary winch, slewing area limitation, additional oil cooler, special painting and lettering.

Further optional equipment available upon request.



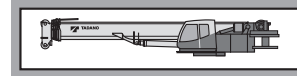
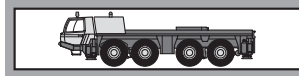

**Châssis** Construction mécanosoudée, en acier à grain fin très rigide, résistante aux flexions et aux torsions. Graissage centralisé.

**Calage** Dispositif de calage horizontal et vertical en 4 points, entièrement déployable hydrauliquement. Commande des mouvements sur les deux côtés du porteur et depuis la cabine de la superstructure. Calage 7,2 m (aussi 5,0 m) x 8,5 m.

**Moteur** Mercedes Benz diesel 6 cylindres, modèle OM 470 LA (Euromot IV / EPA Tier 4f), refroidi par eau, de 320 kW (435 CV) à 1700 min<sup>-1</sup>. Couple: 2100 Nm à 1300 min<sup>-1</sup>. Puissance selon ECE R 120. Capacité du réservoir 400 l. AdBlue-capacité du réservoir 40 l.

**Boîte de vitesse** Boîte mécanique ZF-AS-Tronic, modèle 12 AS 2531 avec embrayage à sec électro-pneumatique et Commande des vitesses automatique, 12 vitesses AV et 2 vitesses AR. Ralentisseur hydrodynamique, type Intarder directement accouplé à la boîte.

**Boîte de transfert** À 2 gammes.

**Entraînement** 8 x 6 (8 x 8 option).

### Essieux

- 1<sup>er</sup> essieu: directeur, non entraîné.
- 2<sup>ème</sup> essieu: directeur, entraîné, blocage de différentiel transversal.
- 3<sup>ème</sup> essieu: directeur, entraîné, blocage de différentiel longitudinal et transversal.
- 4<sup>ème</sup> essieu: directeur, entraîné, blocage de différentiel transversal.

**Suspension** Hydro-pneumatique, avec réglage de niveau.

**Freins** Système de frein à disques, à air comprimé, à double circuit avec système ABS. Frein de stationnement: avec accumulateurs à ressort agissant sur le 2<sup>ème</sup>, 3<sup>ème</sup> et 4<sup>ème</sup> essieu. Intarder et frein moteur conçu comme, frein continu.

**Pneus** 8 x 445/95 R 25 (16.00 R 25), (largeur 2,75 m).

**Direction** Servocom à double circuit, marque ZF. Direction mécanique du 1<sup>er</sup> et 2<sup>ème</sup> essieu, à assistance hydraulique, direction du 4<sup>ème</sup> essieu jusqu'à une vitesse de 25 km/h, avec pompe de direction auxiliaire. Direction de tous les essieux possible. Direction hydro-statique de tous les essieux depuis la cabine du grutier.

**Cabine** Cabine frontale bi-place, construction en matière composite fibre de verre et acier. Vitrage en verre de sécurité, siège conducteur chauffant, sièges suspendus pneumatiquement. Chauffage à eau chaude relié au moteur, radio / CD-player. Organes de contrôle et de commande pour la conduite. Régulateur de vitesse, système automatique de freinage.

**Système électrique** 24 V courant continu, 2 batteries, illumination des calages. Conforme aux normes CE.

**Équipement supplémentaire** (avec supplément de prix) Attache-remorque, chauffage auxiliaire indépendant du moteur avec préchauffage du moteur, climatisation, entraînement 8 x 8, pneus 525/80 R 25 (20.5 R 25), roue de secours, peinture spéciale et inscription. Autres équipements supplémentaires sur demande.

**Plate forme** Construction mécano-soudée résistante à la torsion. Couronne d'orientation à billes à une rangée, à denture extérieure, permettant une rotation illimitée sur 360°. Graissage centralisé.

**Moteur** Mercedes-Benz diesel 4 cylindres, modèle OM 924 LA (Euromot IV / EPA Tier 4f), refroidi par eau, Réglage en continu du nombre de tours par pédale, de 129 kW (175 CV) à 2200 min<sup>-1</sup>. Couple: 750 Nm à 1200 - 1600 min<sup>-1</sup>. Puissance selon ECE R 120. Capacité du réservoir 220 l. AdBlue-capacité du réservoir 10 l.

**Système hydraulique** Diesel-hydraulique à 3 circuits, 1 double pompe à pistons axiaux à régulation de puissance (à réglage électrique) 1 pompe à pistons axiaux et 2 pompes à engrenages, refroidisseur d'huile.

**Commande** 2 manipulateurs à commande en croix (4 sens), assistés électriquement.

**Flèche télescopique** 1 flèche de base et 5 éléments télescopiques en acier fin très rigide, 1 vérin télescopique, hydrauliquement télescopable avec charge partielle. Longueur de 11,1 m à 51,2 m. Tête de flèche avec 7 poulies.

**Mécanisme de relevage** 1 vérin différentiel muni de clapet de freinage de descente.

**Mécanisme de levage** Moteur à pistons axiaux, tambour de levage avec boîte planétaire incorporée, frein d'arrêt à disques multiples à ressort, libéré lors du levage. Câble de levage avec dispositif 'Super-Stop'.

**Orientation** Moteur à pistons axiaux avec entraînement planétaire à 2 gammes. Frein de service actionné par l'intermédiaire d'une pédale et frein de stationnement. Vitesse de rotation 0 à 2 min<sup>-1</sup> en continu.

**Contrepoids** Standard 6.0 t divisible, commandé depuis la cabine du grutier.

**Cabine du grutier** Cabine de grue spacieuse, construction en matière combinée acier / synthétique, avec vitrage de sécurité en verre teinté, siège chauffant, réglable et amorti mécaniquement, inclinable avec instruments de commande, chauffage auxiliaire non alimenté par le moteur, avec préchauffage du moteur, climatisation, radio / CD-player, éléments de commande et de contrôle pour travaux sur chantier, conduite et calage de la grue depuis la cabine du grutier.

**Système électrique** 24 V courant continu, 2 batteries.

**Dispositifs de sécurité** Limiteur de charge (CEC), limitation de zone de travail, interrupteur de fin de course de levage et de treuil, indicateur du nombre de tours, anémomètre, soupapes de sécurité contre ruptures des conduites et flexibles, clapets de non retour sur verins hydrauliques.

**Équipement supplémentaire** (avec supplément de prix) 'Lift Adjuster', fléchette 10,0 m / 18,0 m au choix inclinable 0°, 20° et 40° ou hydrauliquement 0° à 40°, fléchette pour levage lourde 1,6 m, contrepoids additionnel de 16,5 t, combinaison différentes de contrepoids 0 t / 5,1 t / 6,0 t / 7,6 t / 10,2 t / 16,3 t / 22,5 t, sélection de moufles, 2<sup>ème</sup> treuil de levage, limitation de rotation, refroidisseur d'huile supplémentaire, peinture spéciale et inscription. Autres équipements supplémentaires sur demande.

## Equipo

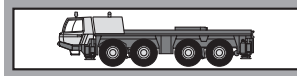

**Chasis portante** Construcción de acero de alta resistencia soldado, resistente a la torsión y a la flexión. Sistema de engrase central.

**Estabilizadores** Estabilizadores hidráulicos de 4 puntos. Posibilidad de manejo desde ambos lados del chasis portante y desde la cabina de la grúa. Extensión de los estabilizadores: 7,2 m (y 5,0 m) x 8,5 m.

**Motor** Mercedes-Benz modelo OM 470 LA (Euromot IV / EPA Tier 4f), 6 cilindros, diesel, refrigerado por agua. Nominal 320 kW (435 CV) a 1700 min<sup>-1</sup>. Par 2100 Nm a 1300 min<sup>-1</sup>. Potencia del motor según ECE R 120. Depósito de combustible de 400 l. Depósito AdBlue 40 l.

**Transmisión** Transmisión mecánica tipo ZF-AS Tronic modelo 12 AS 2531 con intarder integrado, accionamiento electro-neumático embrague en seco y cambio automático, 12 marchas delanteras y 2 marchas traseras.

**Transmisión** Caja de distribución (transfer) con 2 relaciones de velocidad.

**Tracción** 8 x 6 (8 x 8 opción).

### Ejes

1º eje: de dirección, no accionado.

2º eje: de dirección, accionado, con bloqueo diferencial transversal.

3º eje: de dirección, accionado, con bloqueo diferencial transversal y longitudinal.

4º eje: de dirección, accionado, con bloqueo diferencial transversal.

**Suspensión** Suspensión hidroneumática con regulación de nivel.

**Sistemas de frenos** Sistema de frenos de disco neumático de doble circuito con Sistema anti bloqueo ABS. Freno de estacionamiento del tipo freno de muelle, accionando sobre los ejes 2º, 3º y 4º. Intarder y freno motor como freno continuo.

**Neumáticos** 8 x 445/95 R 25 (16.00 R 25), (ancho 2,75 m).

**Dirección** Hidráulica ZF Servocom de doble circuito. Dirección mecánica del 1º y 2º eje y direccionable del 4º eje hasta una velocidad de 25 km/h, con asistencia hidráulica, con bomba hidráulica de emergencia. Dirección de todos los ejes posible. Desde la cabina de la superestructura: dirección hidro-estática de todos los ejes.

**Cabina** Cabina avanzada para dos personas, en construcción de acero y fibra de vidrio. Cristales de seguridad, asientos con suspensión neumática, asiento de conductor calefactado. Calefacción por agua caliente del motor, radio / CD-player. Elementos de control y manejo para circular por carretera. Regulador de velocidad, sistema automático de frenado.

**Sistema eléctrico** Sistema de 24 V c.c. con 2 baterías, faros de trabajo en los estabilizadores. El sistema eléctrico cumple la normativa CE.

**Equipo adicional** (con suplemento de precio) Embrague de remolque, calefacción adicional con precalefacción del motor, climatización, tracción 8 x 8, neumáticos 525/80 R 25 (20.5 R 25), rueda de repuesto, pintura especial y rotulación.

Otros equipamientos sobre pedido.

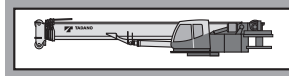

**Superestructura** Construida en aceros soldados, resistente a la torsión. Corona de giro con rodamiento de una fila de bolas con dientes externos para giro continuo de 360°. Sistema de engrase central.

**Motor** Mercedes-Benz modelo OM 934 LA (Euromot IV / EPA Tier 4f) 4 cilindros, diesel, refrigerado por agua. Las revoluciones aumentan de forma gradual accionando el acelerador. Nominal 129 kW (175 CV) a 2200 min<sup>-1</sup>. Par 750 Nm a 1200 - 1600 min<sup>-1</sup>. Potencia del motor según ECE R 120. Depósito de combustible de 220 l. Depósito AdBlue 10 l.

**Sistema hidráulico** Sistema dieselhidráulico de 3 circuitos, 1 bomba doble de pistones axiales de caudal variable (regulable eléctricamente) una bomba de pistones axiales y 2 bombas de engranajes en tandem, enfriador de aceite.

**Mandos** 2 palancas de control de tipo joy-stick para movimientos simultáneos de la grúa (4 direcciones), asistidas eléctricamente.

**Pluma telescópica** 6 secciones, un tramo base y 5 telescópicos de acero de alta resistencia soldado, 1 cilindro hidráulico, los tramos se pueden telescopar hidráulicamente bajo carga. Longitud de 11,1 m a 51,2 m. Cabeza de pluma con 7 poleas.

**Elevación de pluma** Mediante un cilindro diferencial, con válvula de bloqueo de frenado de descenso integrada.

**Cabrestante principal** Motor hidráulico de pistones axiales, tambor del cabrestante con reducción planetaria y freno de discos múltiples cargado por resorte, con sistema libre de elevación. Cable de elevación con sistema 'Super-Stop'.

**Sistema de giro** Motor hidráulico de pistones axiales con reducción planetaria de dos etapas. Freno de servicio controlado por pedal y freno de estacionamiento. Velocidad de giro variable de 0 a 2 min<sup>-1</sup>.











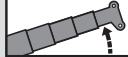
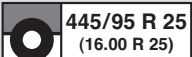
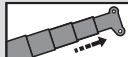

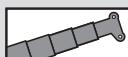
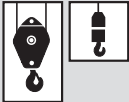







**Contrapeso** Estándar: 6,0 t divisible, se acciona desde la cabina de la grúa.

**Cabina de la grúa** Cabina espaciosa y confortable, en construcción de acero y fibra de vidrio, con cristales tintados de seguridad. Asiento de operador regulable amortiguado mecánico, inclinable junto con los instrumentos y mandos, asiento calefactado. Calefacción independiente del motor y precalefacción del motor, climatización, radio / CDplayer. Controles, instrumentos y mandos de conducción para la operación de la grúa y para el desplazamiento en obra. Mandos para nivelación y extensión de los estabilizadores.

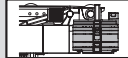
**Sistema eléctrico** Sistema de 24 V c.c. con 2 baterías.

**Medidas de seguridad** Limitación del momento de carga (LMC), limitación del área de trabajo, interruptor de final de elevación, interruptor de 3 últimas vueltas en cabrestante, indicador de bajada o subida del cable del cabrestante, anemómetro, válvulas de seguridad para rotura de tubos y latiguillos. Válvulas de retención en los cilindros hidráulicos.

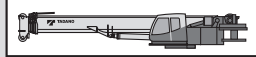
**Equipo adicional** (con suplemento de precio) 'Lift Adjuster', plumín de 10,0 m / 18,0 m regulable hidráulicamente de 0°, 20° y 40° (o hidráulicamente 0° a 40°), plumín de carga pesada de 1,6 m, contrapeso adicional de 16,5 t, variantes de contrapeso 0 t / 5,1 t / 6,0 t / 7,6 t / 10,2 t / 16,3 t / 22,5 t, selección de ganchos, 2º cabrestante, limitador de giro, enfriador de aceite adicional, pintura especial y rotulación. Otros equipamientos sobre pedido.

|   |  |   |  |
|---|--|---|--|
|    | <p>Siehe Seite 17<br/>         As on Page 17<br/>         Voyez la page 17<br/>         Véase la pagina 17</p>   |     | <p>Wippwerk<br/>         Derricking system<br/>         Mécanisme de relevage<br/>         Elevación de pluma</p>  |
|    | <p>Räder / Größe<br/>         Tyres / Size<br/>         Pneus / Largeur<br/>         Neumáticos / Tamaño de ruedas</p>   |     | <p>Teleskopieren<br/>         Boom telescoping<br/>         Téléscopage de flèche<br/>         Telescopaje de pluma</p>                                      |
|    | <p>Achslast<br/>         Axle load<br/>         Charge à l'essieu<br/>         Carga por eje</p>   |     | <p>Teleskopausleger<br/>         Telescopic boom<br/>         Flèche télescopique<br/>         Pluma telescópica</p>   |
|    | <p>Unterflasche / Hakengeschirr<br/>         Hook block / Swivel hook<br/>         Moufle / Elingues<br/>         Gancho / Gancho de bola</p>  |     | <p>Abstützung<br/>         Outriggers<br/>         Calage<br/>         Estabilizadores</p>   |
|  | <p>Geschwindigkeiten Unterwagen<br/>         Carrier speeds<br/>         Vitesses du châssis<br/>         Velocidades del chasis</p>   |  | <p>Gegengewicht<br/>         Counterweight<br/>         Contrepoids<br/>         Contrapeso</p>  |
|  | <p>Getriebe / Gang<br/>         Transmission / Gear<br/>         Boîte de vitesse / Rapport<br/>         Transmisión / Marchas</p>   |   | <p>Ausladung<br/>         Radius<br/>         Portée<br/>         Radio</p>  |
|  | <p>Steigfähigkeit<br/>         Gradeability<br/>         Abtitude en pente<br/>         Superacion de pendientes</p>   |   | <p>Auslegerverlängerung<br/>         Boom extension<br/>         Fléchette<br/>         Plumin</p>   |
|  | <p>Gelände<br/>         Off road<br/>         Tout-terrain<br/>         Todo terreno</p>   |   | <p>Auslegerverlängerung hydraulisch<br/>         Boom extension hydraulically<br/>         Fléchette hydrauliquement<br/>         Plumin hidráulicamente</p> |
|  | <p>Straße<br/>         On road<br/>         En route<br/>         En carretera</p>   |   | <p>Ausladung<br/>         Radius<br/>         Portée<br/>         Radio</p>  |
|  | <p>Geschwindigkeiten Oberwagen<br/>         Superstructure speeds<br/>         Vitesses du partie tournante<br/>         Velocidades de la superestructura</p>   |   | <p>Gegengewichtvarianten<br/>         Counterweight versions<br/>         Variations des contrepoids<br/>         Variaciones de contrapeso</p>              |
|  | <p>Hubwerk<br/>         Main winch<br/>         Mécanisme de levage<br/>         Cabrestante principal</p>   |   | <p>Unterwagen<br/>         Carrier<br/>         Châssis<br/>         Chasis</p>  |
|  | <p>2. Hubwerk<br/>         Auxiliary winch<br/>         2<sup>ème</sup> treuil de levage<br/>         2<sup>o</sup> cabrestante</p>  |   | <p>Oberwagen<br/>         Superstructure<br/>         Partie tournante<br/>         Superestructura</p>  |
|  | <p>Drehwerk / hydraulisch verriegelt<br/>         Slewing system / hydraulically locked<br/>         Orientation / hydrauliquement verrouillé<br/>         Sistema de giro / Embulonamiento hidráulico</p> |   |  |



**TADANO FAUN GmbH**

Faunberg 2, 91207 Lauf a. d. Pegnitz, Germany  
Phone: +49-9123-185-0 Fax: +49-9123-3085  
<http://www.tadanofaun.de> E-mail: [info@tadanofaun.de](mailto:info@tadanofaun.de)

**TADANO LTD.** (International Division)

4-12, Kamezawa 2-chome, Sumida-ku Tokyo 130-0014, Japan  
Phone: 81-3-3621-7750 Fax: 81-3-3621-7785  
<http://www.tadano-global.com> E-mail: [tdnihq@tadano.co.jp](mailto:tdnihq@tadano.co.jp)